

A5MHA SERIES

Modular Air-Source Heat
Pump Water Units



ACSON[®]
International
Air Conditioners

A5MHA ACSON MODULAR AIR SOURCE HEAT PUMP HOT WATER UNITS

A5MHA series modular air-source heat pump hot water unit is the accumulation of our vast experience in Malaysia HVAC industry for more than three decades. A5MHA have excellent EER, wide operating range, and friendly management system. It is perfectly designed for Malaysia hot weather, providing an affordable hot water solution for all year long.





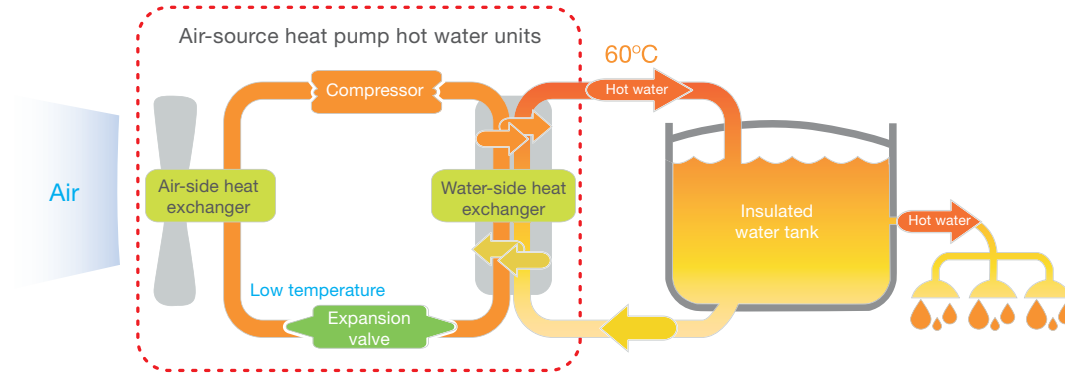

1 What is the air-source heat pump hot water units?

Air-source heat pump hot pump water harness the energy from surrounding hotter environment. It is an efficient system because it uses much lesser energy compare to conventional water heater. At the same time require lesser initial investment compare to other green energy alternatives.



2 Compared with other hot water equipments, what are the advantages of air source heat pump hot water units?

Category	Profile	Energy property	Performance	Safety	Initial Investment	Operation & Maintenance cost
Boiler (oil/gas)		Primary Energy	<ol style="list-style-type: none"> 1. Facilities for fuel storage or transportation are required. 2. Environment pollutants discharged during operation. 	There is hidden danger of leaking oil (gas) fire or explosion	Lowest	High
Electric boiler		Secondary energy	<ol style="list-style-type: none"> 1. Directly use electricity for making domestic hot water, huge power consumption. 2. The electric heating pipe is apt to age and fur, must be maintained on a regular basis. 	Hidden danger of electric leakage	Low	Medium
Solar energy boiler		Renewable energy	<ol style="list-style-type: none"> 1. Greatly influenced by the weather, auxiliary heat source has to be equipped to keep the water temperature. 2. Large installation area, and sun direction has to be considered. 3. Poor destructive resistance, easy to damage. 	Safe & reliable	High	Lowest
Air-source heat pump hot water heater		Secondary energy	<ol style="list-style-type: none"> 1. Mainly use clean air energy, high efficiency and no pollution. 2. Outdoor installation, small footprint. 	Safe & reliable	Medium	Low



A5MHA Acson Modular Air Source Heat Pump Hot Water Units

A5MHA utilize Malaysia hot weather by providing a stable yet economical hot water solution. It is suitable for both residential and commercial application ranging from normal household to hotels and process heating for factory.

Residential: Houses, condominiums, villas and etc

Safety

Separation of water and electricity, does not pose electrical hazard and emittance of harmful gas. A reliable and safe to use system

Comfortable

Excellent in retaining the desired water temperature, ensuring comfort for all.

Energy Saving

Operation cost is 1/5 of the electric water heater and 2/3 of conventional solar energy water heater.

Environmental Friendly

Low noise, no waste heat, water or gas emissions, and reduce heat island effect.



Multi-storey residential



High-rise apartment



Villas



Commercial: Hotel, Inn, Homestay, Laundry Shop

Reliable Operation

A system that capable to be operated come rain or shine. Compare to solar heater where it will render inoperable during night time.

Ease of Installation

No location restriction(sun shine exposure time as in solar heater) and dedicated machine room. Rather small footprint compare to solar energy to be effective.

Security

Using refrigerant as the source of heating, it enable the separation of water and electricity possible. Ensuring a safe and reliable system.



Laundry shop

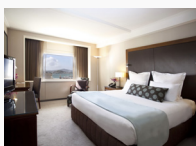

Hotel room



Dining room

Commercial: Factory, hospital, hostel, motel and etc.

Intelligent Control

Intelligent control: Unit operations is pre-programmed with sophisticated algorithm. That is control based on water temperature and usage. It can operate with minimal human supervision.

Investment Diversification

A5MHA-B is using modular structure making it is possible to have staging investment. Upgrading only when the need arise and financial capacity is available.

Versatility

A5MHA-B could be use with existing thermal storage tanks, gas and oil-fired boilers, making it is suitable for retrofit or restoration project.



Factory



Hospital



Dormitory

Common Features

Wide Range of Operation

A5MHA series have wide operating range, from -20°C to 43°C.

A5MHA Series

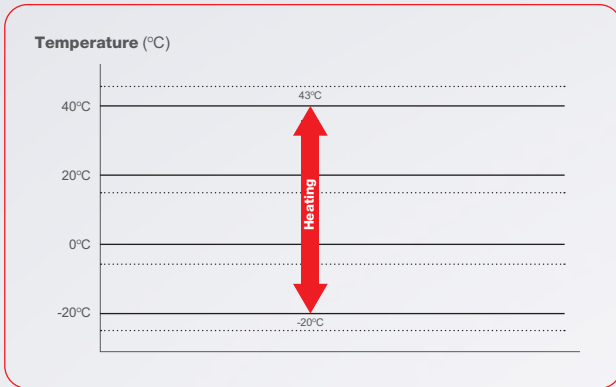

Dedicated Compressor For Hot Water Unit

A5MHA series hot water heat pump unit uses a dedicated compressor. It has a unique “spray liquid” design, during low temperature operation. Liquid refrigerant is sprayed onto the middle of the scroll compressor cooling chamber to cool down and lower exhaust gas temperature to ensure reliability and security. This unique “spray liquid” design greatly enhances the efficiency and operating range.

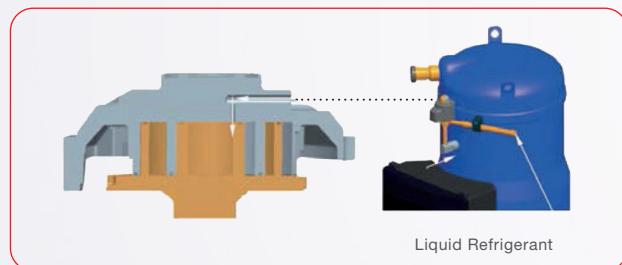

No Harmful Substances

A5MHA uses no hazardous material nor will it generate toxic or pollutant. It is a greener solution because instead of discharging residual waste heat such as fossil fuel boiler, it recycles/absorbs heat from surrounding to heat up the water. At the same time it discharges cool air to the surrounding, alleviating the urban heat island effect at the same time.



Environmental-Friendly Refrigerant

A5MHA is incorporated with R410A refrigerant into its system, which is an environmental friendly refrigerant with 0 ODP. Coupled with other technological advancement, A5MHA is an economical, efficient and greener hot water solution.

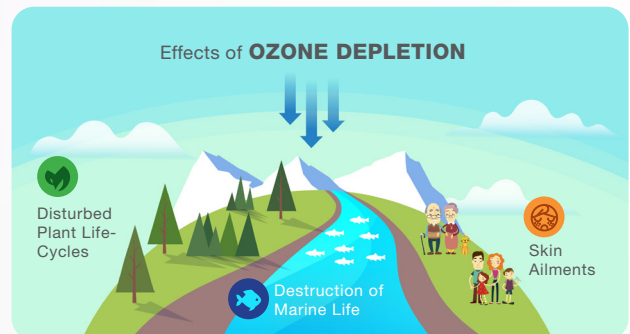

Seamless Temperature Control

Compare to conventional solar heater, user will “run out” of hot water if we continuously uses hot water because demand is higher than supply. A5MHA control through both the temperature and water level of the tank. Ensuring a stable temperature for its user.

A5MHA Series

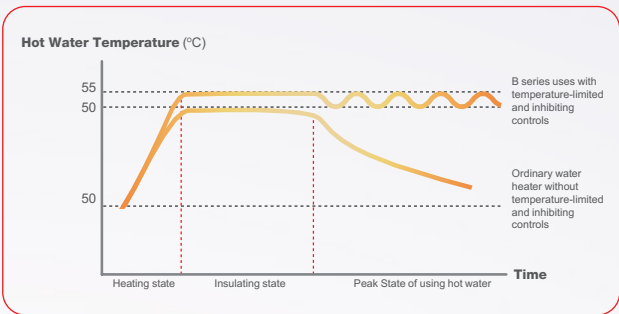

Schedule Management

A5MHA is able to be programmed for one week cycle. For example, it could be programmed to operate during the day time where it will be efficient and heat water is store in a well-insulated water tank for later use.



LCD Wired Controller

A user friendly LCD wired controller that can link up to 16 units. It display modes, error codes and other informations for easier management and troubleshooting.

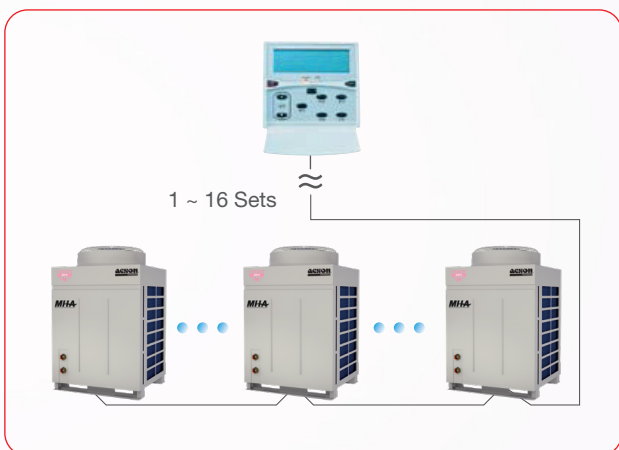

Modbus for Building Management System (BMS) (Optional)

A5MHA-B Series have built in ModBus gateway protocol. Making it is possible for user that wish to have centralized control and smart management system.

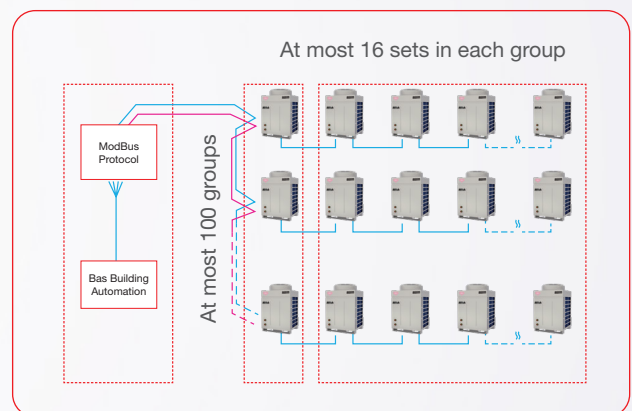

Common Features

Flexible Application

The unit uses a modular design, enabling free combination of 1 to 16 different units, and can be combined freely between different models to meet hot water needs of different places. When design capacity of the units change, or phased investment of project is required, it can respond flexibly.

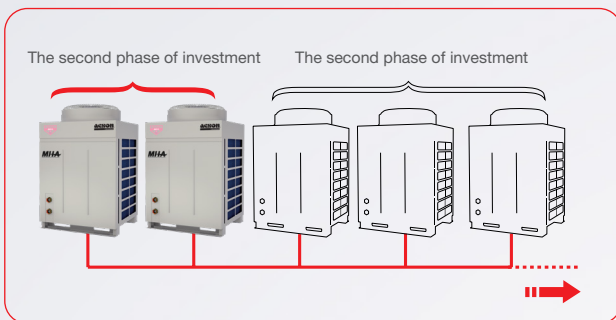

Convenient Installation

A5MHA-B is compact enough to be delivered by elevators without any large delivering or lifting equipment. It can be delivered separately and combine latter, making it ideal user that wish to expand in future.



System Redundancy

With modular design, user can avoid total shut down to their system. Multiple unit system, could still function if one of their unit is in need of maintenance

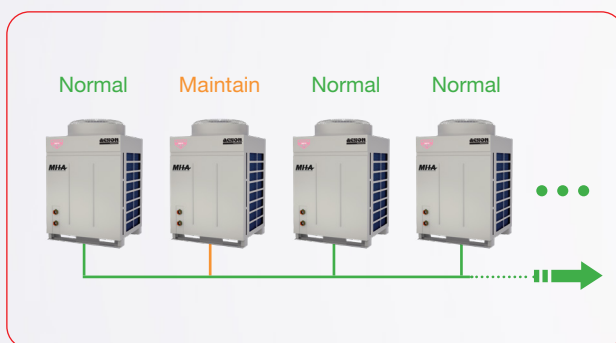

Intelligent Defrosting

Using its sensor and delicate algorithm, A5MHA-B can accurately determine the frosting in unit and enter defrosting mode. Having dual system in one unit, enable it have interval defrosting and avoid excessive temperature fluctuation.



Applications

A5MHA – B series have variety of application from providing to hot water solution to more sophisticated hot water and energy recovery system. Below are some of these systems:

Here are some typical system applications:

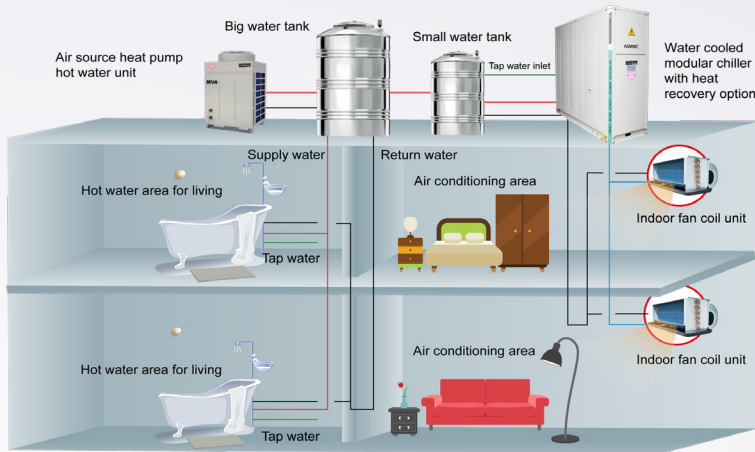

System 1

Water cooled modular chiller recovery system + A5MHA-B Air source heat pump hot water

Water cooled modular chiller heat recovery unit provide cooling solution at the same time it could either pre-heat the water so that even lesser energy is required for A5MHA-B series to heat up the water

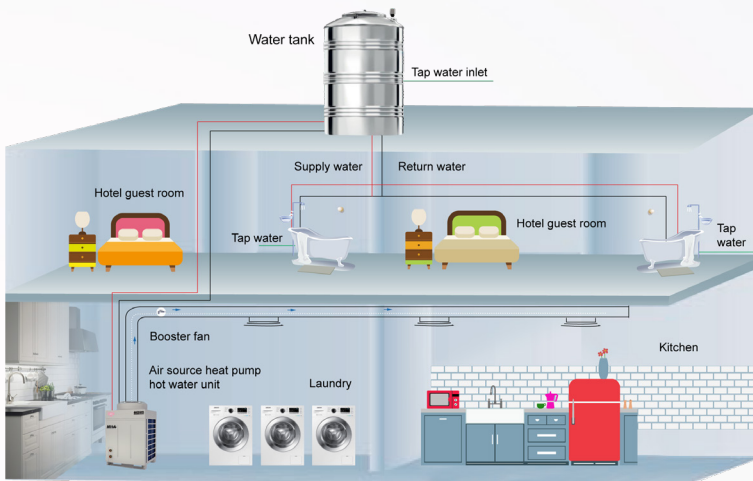

System 2

Heat recovery system

A5MHA – B unit is place into hot places such as kitchen, laundry, and dryer room. It can cool down the area and at the same time provide hot water needs to other area.

Note:

- Tap water from public water works
- Chilled water supply piping
- Hot water supply piping
- Return water piping

Specifications

ACSON MODULAR AIR-SOURCE HEAT PUMP (A5MHA B Series)

Model			A5MHA075B	A5MHA100B	A5MHA200B
Nominal Capacity	kW		30	40	80
Nominal Total Input Power	kW		6.83	8.71	18.22
Nominal Running Current	A		13.20	17.30	33.40
C.O.P.	W/W		4.39	4.59	4.39
Power Source	V/Ph/Hz		380 - 415V / 3 / 50		
Nominal Water Flowrate	m³/h		5.16	6.88	13.76
Water Pressure Drop	kPa		35	58	72
Expansion Device			Electronic Expansion Valve		
Air Flowrate	m³/h		8,725	11,846	23,692
Sound Pressure Level	dBA		60	62	65
Heat Exchanger		Type	Tube - in - Tube		
Operating Range	Ambient Temperature	°C	-20 - 43		
	Water Tank Water Temperature	°C	25 - 55		
	Maximum Leaving Water Temperature	°C	60		
Unit Dimension	Height	mm (in)	1,515 (60)		1,780 (70)
	Width	mm (in)	990 (39)		1,990 (78)
	Depth	mm (in)	840 (33)		
Packing Dimension	Height	mm (in)	1,700 (70)		1,960 (77)
	Width	mm (in)	1,080 (43)		2,070 (81)
	Depth	mm (in)	890 (35)		
Piping	Inlet	Type	BSP - Female Thread		
		Size	1-1/2"		2"
	Outlet	Type	BSP - Female Thread		
		Size	1-1/2"		2"
Refrigerant	Type		R410A		
	Charge	kg (lb)	4.1	5	5.0 x 2
Unit Weight	Operating	kg (lb)	225	255	510
	Net	kg (lb)	220	250	500

- Notes:
- The nominal heating capacity above is measured at outdoor environment DB/WB temperature 20°C/15°C, initial water tank temperature 15°C, and final water temperature 55°C.
 - Nominal water flowrate is the design value for heating operation, Water Pressure Drop is measured during this operation and operating mode.
 - Sound pressure level is measured in a noise chamber which background sound pressure level is 11.5 dB(A).
During actual application, due to environmental noise or other reasons, the sound pressure level may be different.
 - Table above are the parameter of 3 basic models. Arbitrary combination is up to 16 module. Depends on the design, parameters such as nominal water flow rate, heating capacity, refrigerant charging volume and etc. can be calculated by adding up all corresponding parameters of each modular.
 - All specifications are subjected to change by the manufacturer without prior notice.

Heating Capacity Change Table

Standard condition

Model			Ambient Temperature (°C)										
			-10	0	7	10	15	20	25	30	35	40	43
A5MHA 075B	Heating capacity	kW	16.50	21.30	24.50	25.80	27.90	30.00	31.90	33.80	34.90	36.00	37.90
	Heating power	kW	6.54	6.65	6.72	6.75	6.79	6.83	6.84	6.84	6.71	6.57	6.63
	C.O.P.		2.53	3.21	3.64	3.82	4.11	4.39	4.67	4.95	5.22	5.48	5.72
	Water Production	m³/h	0.36	0.46	0.53	0.56	0.60	0.65	0.69	0.73	0.75	0.77	0.81
A5MHA 100B	Heating capacity	kW	22.00	28.50	32.60	34.40	37.20	40.00	42.55	45.10	46.55	48.00	50.50
	Heating power	kW	8.34	8.49	8.57	8.61	8.66	8.71	8.72	8.72	8.55	8.37	8.45
	C.O.P.		2.64	3.35	3.81	4.00	4.30	4.59	4.88	5.17	5.45	5.73	5.98
	Water Production	m³/h	0.47	0.61	0.70	0.74	0.80	0.86	0.92	0.97	1.00	1.03	1.09
A5MHA 200B	Heating capacity	kW	44.10	56.90	65.30	68.90	74.45	80.00	85.10	90.20	93.10	96.00	101.00
	Heating power	kW	17.45	17.75	17.93	18.01	18.12	18.22	18.23	18.24	17.88	17.51	17.68
	C.O.P.		2.52	3.21	3.64	3.82	4.11	4.39	4.67	4.94	5.21	5.48	5.71
	Water Production	m³/h	0.95	1.22	1.40	1.48	1.60	1.72	1.83	1.94	2.00	2.07	2.17

Notes:

The parameters in above table are measured at standard conditions of water tank initial water temperature 15°C, final water temperature 55°C.

Reference Table Of Pipe Diameter Combination Unit

Combination Unit	Entering water pipe diameter		Leaving water pipe diameter	
	A5MHA075/100B	A5MHA200B	A5MHA075/100B	A5MHA200B
1	DN50	DN80	DN50	DN80
2	DN80	DN80	DN80	DN80
3~4	DN80	DN100	DN80	DN100
5~7	DN100	DN125	DN100	DN125
8~11	DN125	DN150	DN125	DN150
12~13	DN125	DN200	DN125	DN200
14~16	DN150	DN200	DN150	DN200

Notes:

1. The above table are recommended main pipe diameter for modular configuration.

2. The main pipe of configuration is field supply, due to there is a lot design options. The pipe size might be different, select pipe size accordingly.

Dimensional Drawings

A5MHA075B, A5MHA100B Outline and Dimension

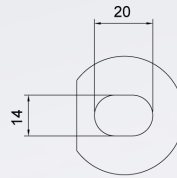
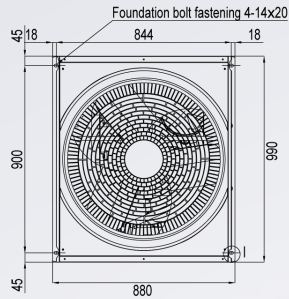

14 x 20 Foundation bolt fastening hole amplified drawing

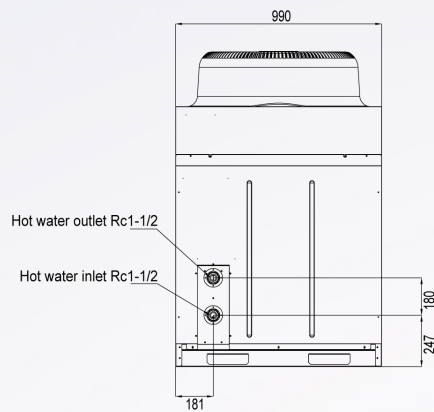
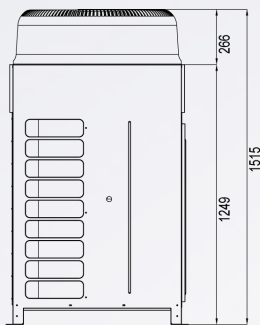

A5MHA200B Outline and Dimension

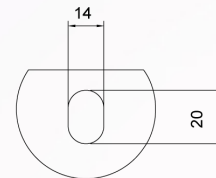
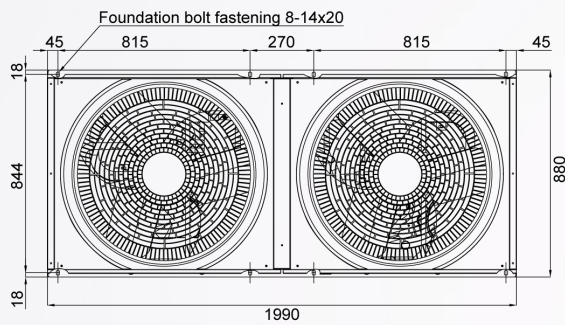

14 x 20 Foundation bolt fastening hole amplified drawing

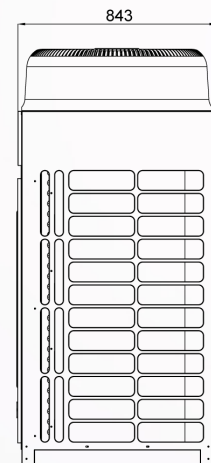
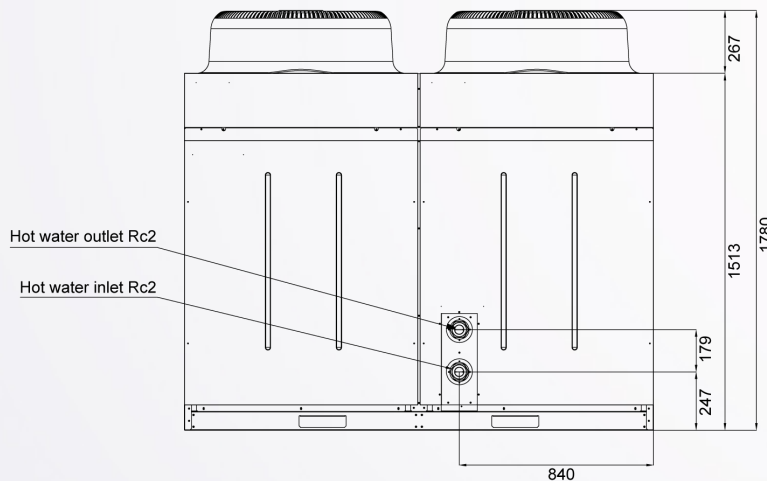

A5MHA075-100B schematic drawing of multiple units installation space requirements.

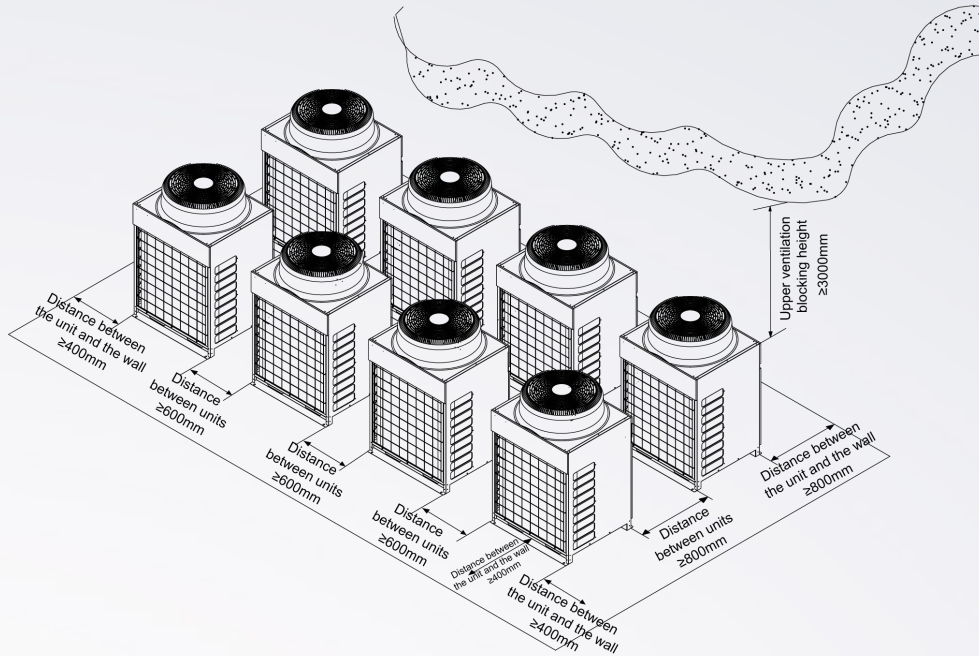

A5MHA200B schematic drawing of multiple units installation space requirements.

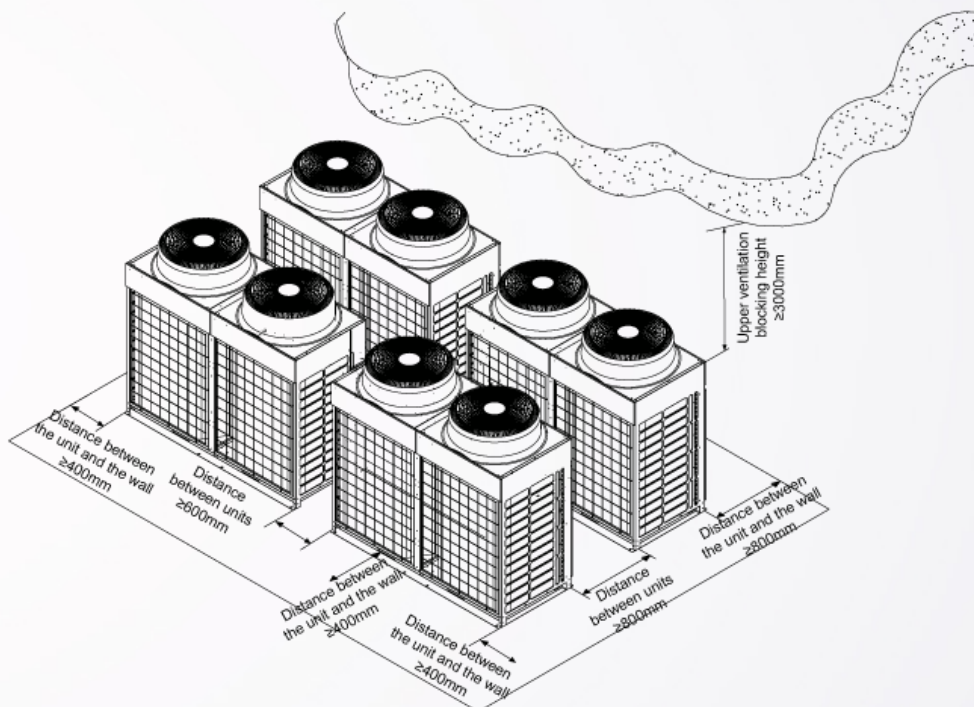

Typical Installation Diagram

Multiple A5MHA-B Unit Connection Diagram

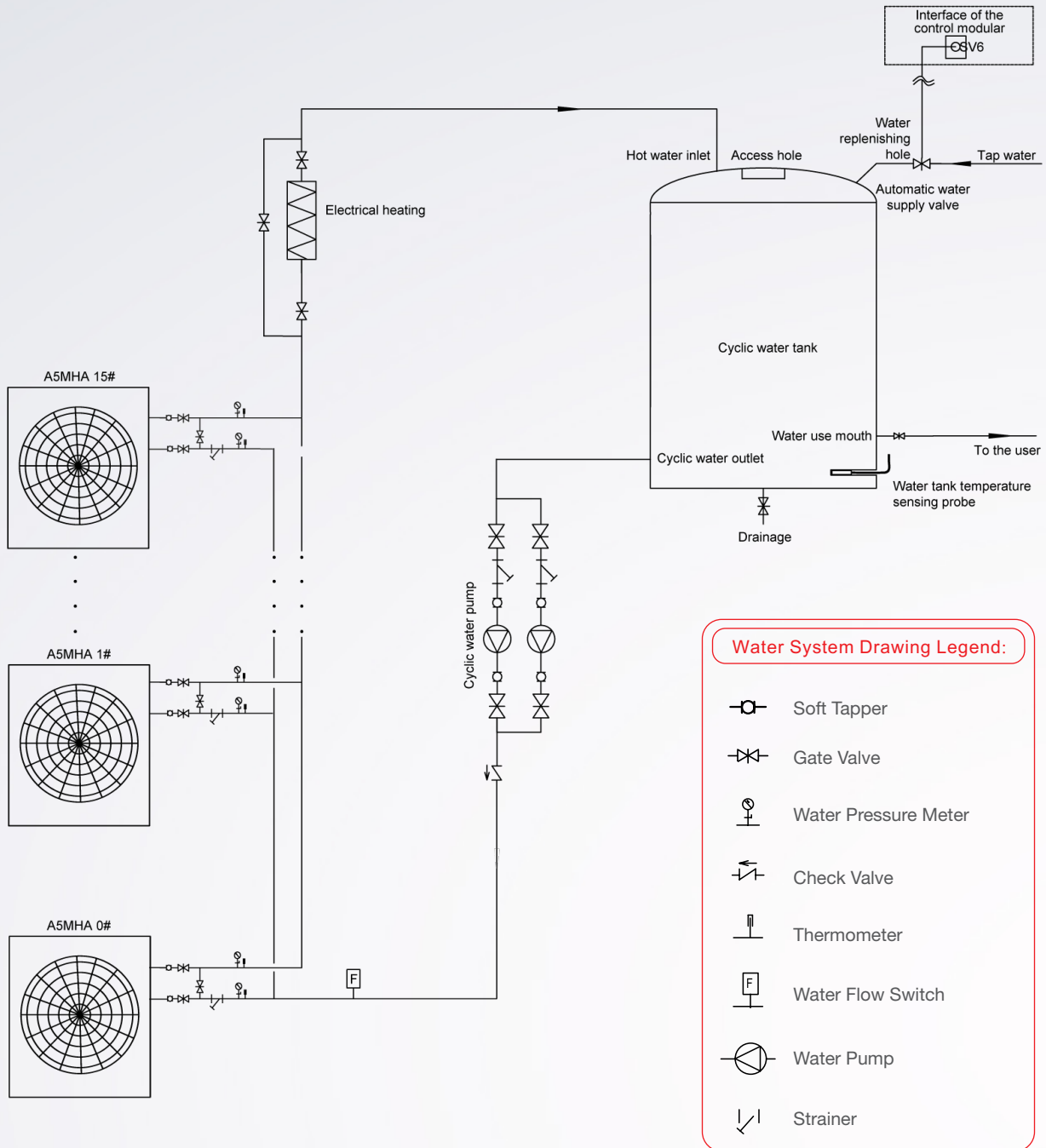

Note:

1. Prior of commissioning, close the gate valve connecting to the units and switch on the water pumps. This is to clear the system from any debris.
2. Hot water inlet must be higher than water circulation inlet. Please refer to the diagram below for more information.
3. It is recommended to use reverse return piping system when more than one unit is installed.
4. It is also recommended to install automatic exhaust valve between the unit and the water tank.

Water Tank Structure Diagram

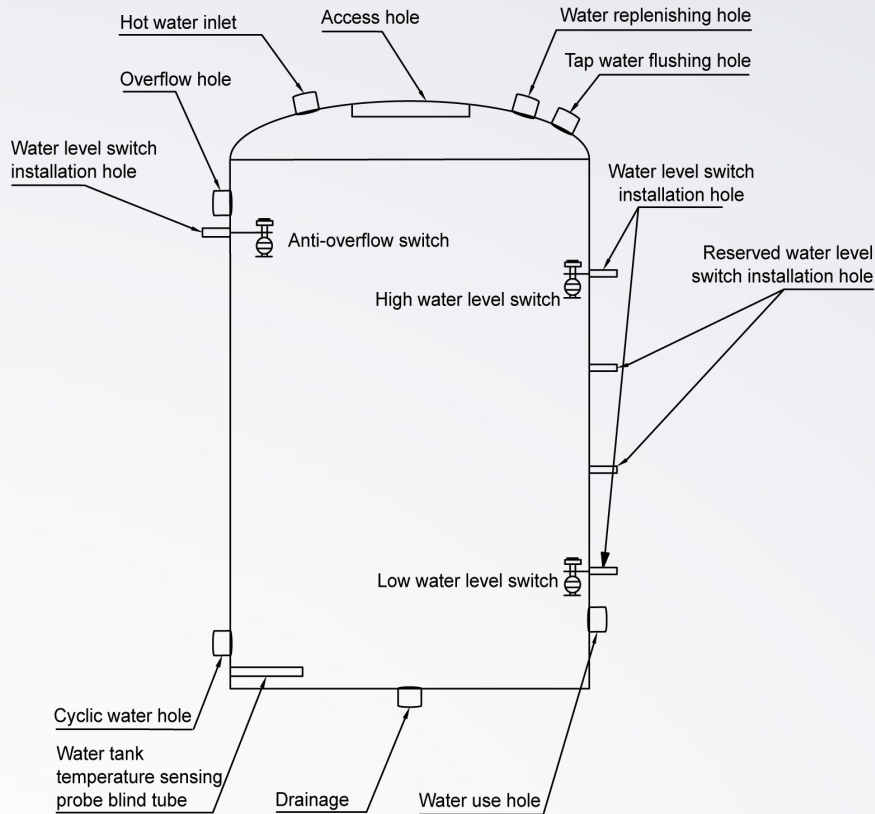

Note:

1. It is a prerequisite that the water tank used for this system to have access inlet, water inlet port, tank rinse water inlet and etc.
2. A thermocouple with a R1/2 connector is installed as default. A RC1/2 slot for thermocouple under the water circulating valve shall be reserve.
3. During the installation of thermocouple, ensure it is inserted into the front of the tube and fill the slot with thermosensitive gel.
Rubber stick shall be use to plug and firmly secure the thermocouple so it will not easily fall off.
4. Water level switch must be strictly installed according to our requirement. Please refer to our manual for more information.
5. Low water level switch must be installed above the water outlet, while water replenishing inlet must be installed above the water circulation outlet.
Failure to do so will damage the unit.
6. Circulation water flow rate must be higher than peak water usage flow rate. Failure to do so will damage the unit.



ACSON MALAYSIA SALES & SERVICE SDN.BHD.
a member of DAIKIN group

Business Registration NO.198401017130 (129688-D)

No. 7A, Jalan 13/4, Seksyen 13, 46200 Petaling Jaya,
Selangor Darul Ehsan, MALAYSIA

Tel : +603 7964 8200 Sales Fax : +603 7956 9909

Service Fax : +603 7956 9907 Acson Careline : 1300 22 3344

Penang	: +604-5377 176	Pahang	: +609-5178 696
Perak	: +605-3129 828	Kelantan	: +609-7405 233
Melaka	: +606-2926 196	Sarawak	: +6082-344 128
Johor	: +607-3551 599	Sabah	: +6088-420 205

www.acson.com.my

Authorized Dealer :

Products manufactured in an ISO certified facility.
This document contains the most current product information as of this printing.
For the most up-to-date product information, please logon to www.acson.com.my