

AVR Alpha

ACSON[®]
International
Air Conditioners



CAT-ASVRF-2402

VARIABLE REFRIGERANT FLOW (VRF)

Air Conditioner

Stepless Inverter Technology

Acson AVR Alpha use the advanced stepless inverter technology, which enables the system to respond rapidly and run stably.

- Ensure the stability of the exhaust pressure and suction pressure of the unit
- Ensure the dynamic distribution of the refrigerant flow is more stable with smaller fluctuation during system operation.
- Enable the system to respond in order to enhance its stability and reliability.

Long Piping Applications

AVR Alpha could provide a degree of stepless capacity loading. Making our Variable Refrigerant Flow (VRF) lineup is versatile and have wide capacity range.

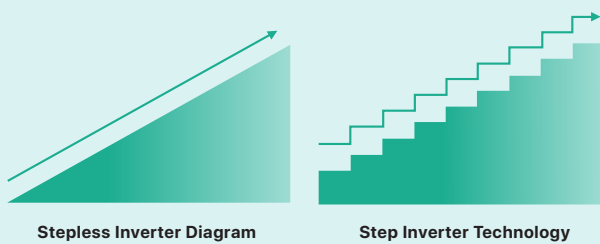

Advance 180° Vector Inverter Control Technology

DC inverter controller generates a smooth 180° sinusoidal waveform. The stator coil of the compressor form a steady rotating magnetic field constantly, and keeps the compressor always running stably from a low speed to a high speed, thereby effectively reducing the vibration and noise of the compressor.

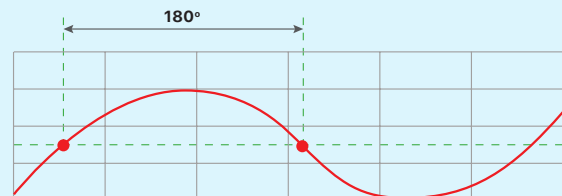

Greater Comfort, Better Accuracy and Stable System

Another special characteristic for inverter system, they are more stable when it comes to temperature control compare to non-inverter system. This minimal temperature fluctuation is vital in providing room comfort.

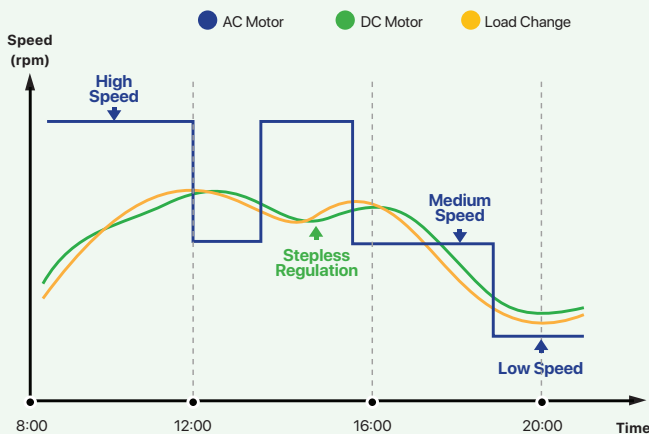
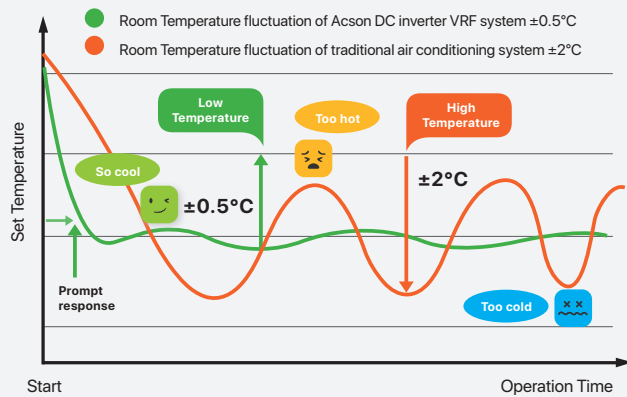

Stepless Inverter Technology- Outdoor Unit

Outdoor unit fan motors use the DC variable speed motors, which greatly improve the operation efficiency. The speed of outdoor unit fan motors can be regulated with the change of the ambient environment to implement stepless variable speed regulation, making the system run precisely.

High Efficiency Heat Exchanger

One of the major component of any direct expansion system is the heat exchanger, the performance of a said system depends on it. Here is the closer look of our variable refrigerant flow heat exchanger:

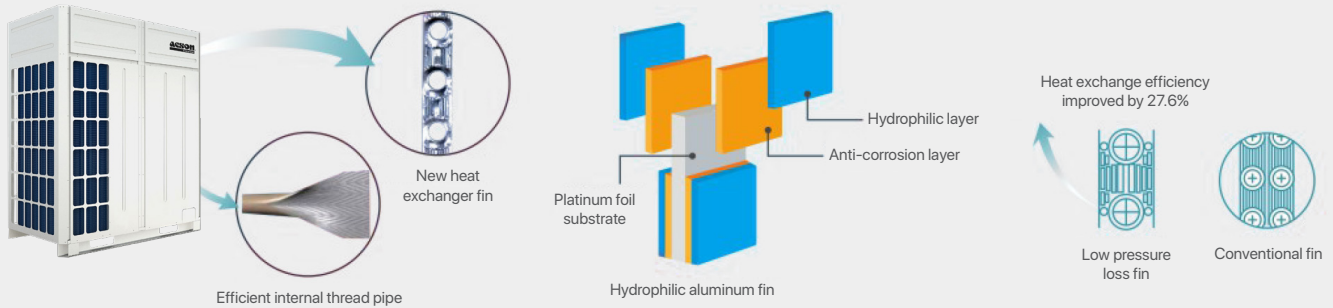

Integrated G-type heat exchanger

- The reasonable integrated three-surface heat exchanger can fully use the unit space and expand the heat exchange area to improve the heat exchange efficiency significantly.
- The reasonable integrated G-type heat exchanger features compact structure, high strength, easy to install and maintain. It is more safe and reliable because less solder joints are required.
- The copper tube adopts small diameter design to implement a higher flow rate and more heat exchange.
- The hydrophilic aluminium fins reduce corrosion occurring on the heat exchanger and improves the heating and cooling performance of the unit.

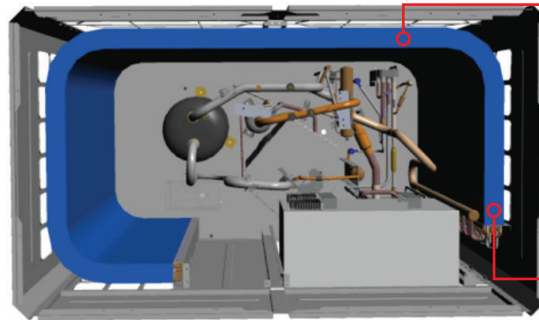

Integrated G-type Heat Exchange Structure

- Enlarging the heat exchange area and improving the heat exchange efficiency

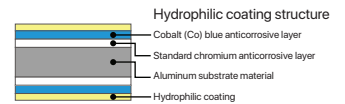

New Hydrophilic Aluminum Fin

- The corrosion-resistant hydrophilic aluminum foil can eliminate condensate water effectively.



Common bare pipe

The inner surface of common bare pipe is smooth, so the contact area with refrigerant is small and the heat exchange efficiency is relatively low.

Inner-grooved copper tube

Acson adopts the highly efficient inner-grooved copper tube with a large surface area and efficient heat exchange performance.

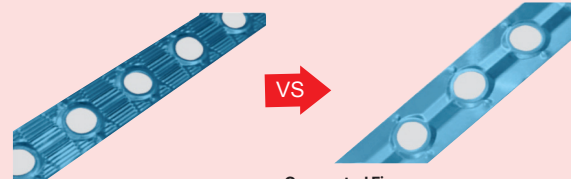

Windowed Fin

The heat exchange efficiency is lower as the frost and water cling to the fin.

Corrugated Fin

The frost is only attached to the outer surface of the fin, which can be removed more expeditious. The streamline design in the vertical direction is conducive to the frost water removing.

Ecosystem Friendly

Similar to our Ecocool lineup, our AVR series use R410A refrigerant. Which at the moment the most probable line-up as R22 refrigerant line-up. It does not deplete the ozone and pose any hazardous threat that most non-ODP refrigerant do. As a responsible corporate, our line-up is also RoHs compliance.

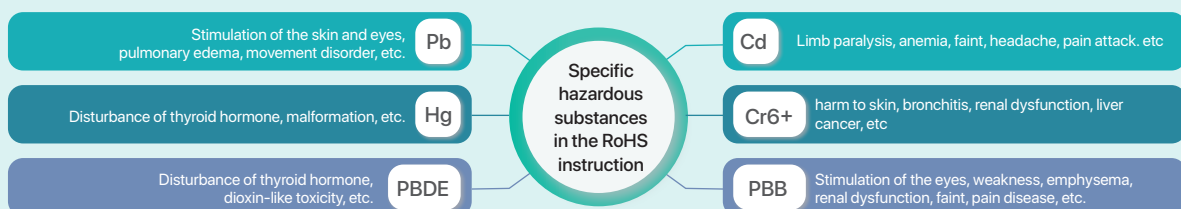

Patented Oil Return Technologies

One of the core design that was input to the design of the system is the oil return. It is vital because the compressor need sufficient oil for it to function effectively. Our system is so efficient that it does not require oil balancing pipe. From the software, we have a smart oil distributing to hardware, we have highly efficient oil separator.

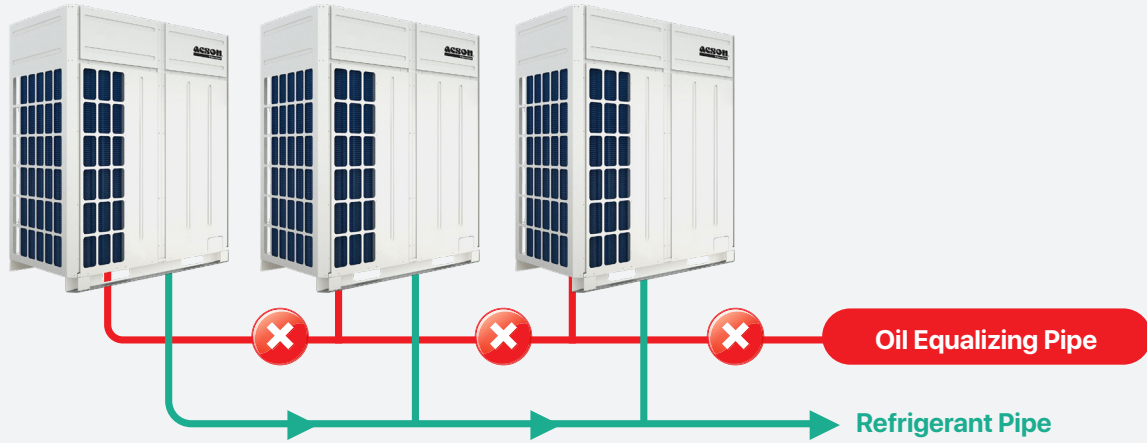

Efficient Oil Separator

The oil separator adopts the efficient centrifugal rotating guide design. After entering the oil separator, the high pressure gas emitted from the compressor forms a high speed rotating air flow. Due to functions of the centrifugal force and gravity, the mixed gas of high pressure refrigerant and oil separates the relatively heavy lubricating oil from the refrigerant gas, and makes it flow to the oil separator device along the inner wall of cylinder. In this way, oil is separated efficiently.

Efficient Large Capacity Oil Separator

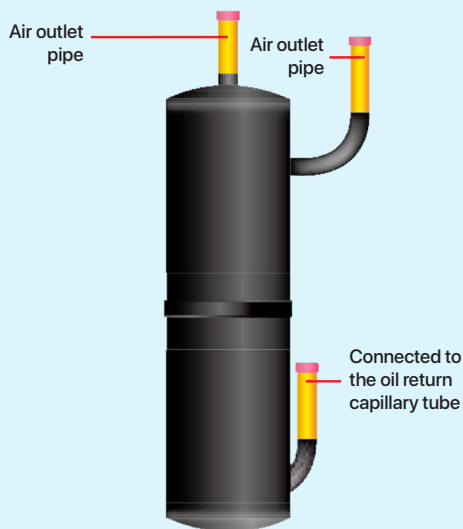

Wide Temperature Range

Unique operating range:

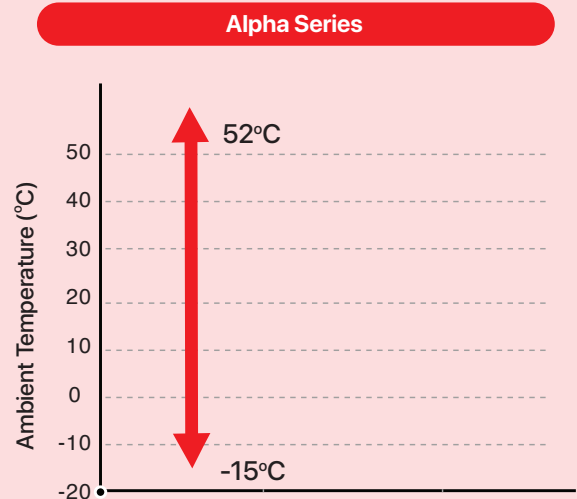

Patented Two Stages Smart Oil Return Technologies

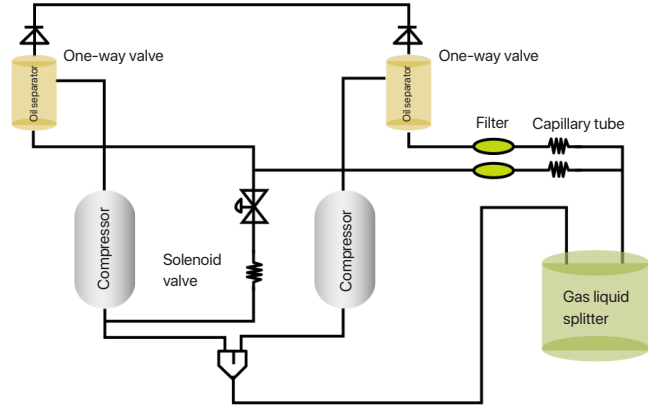
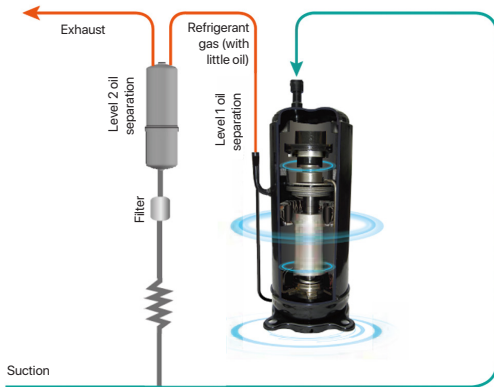

Level 1 Oil Separation & Recovery

The first stage of oil separation occur within the compressor itself using the oil and gas separator and oil return pipe. Almost all of the oil is recycle back into the compressor after it left the compressor, by doing so we can ensure the oil remain in the compressor.

Level 2 Oil Separation & Recovery

After leaving the compressor, there is residue of the oil that left together with the refrigerant. It is still vital to recover the oil back because as time goes. These oil will eventually trapped within the pipe rather than within the compressor where it is needed. Thus, an external oil separator is used to further recover this residue of oil. Maximizing both the service life and efficiency of the unit.

Two Sensor Point

By default, the sensing point for the unit is built in within the unit. However, the comfort level perceived by the occupants in the system might be different. Therefore, we have a built in function that can allow us to choose the location of sensing. Enabling the system to be able to provide a more accurate and comfort environment to the occupants.

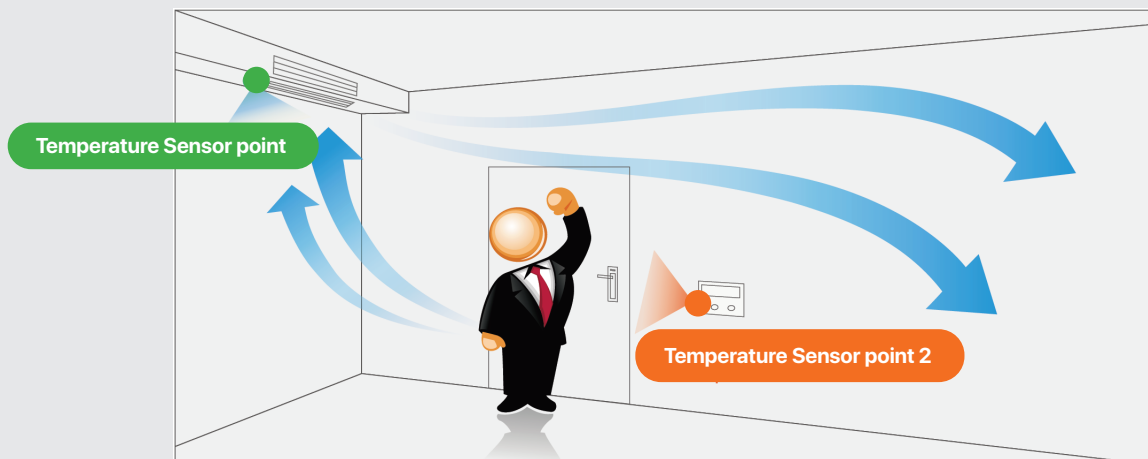

Smart Room

Be it hotel operators or smart home aspirant, our AVR system is capable to perform such function. With a simple card detector or a sensory device such as infrared or sound sensor. We can design the air conditioning system to be operating as if it is self-conscious.

Mode 1

When the user enters the room, the air conditioner with the inserted card is in the standby status. The user can use the controller to start the air conditioner; the user unplugs the card when leaving the room and the air conditioning unit is powered off automatically, which avoids unwanted electricity waste when the user forgets to power off the unit before leaving.

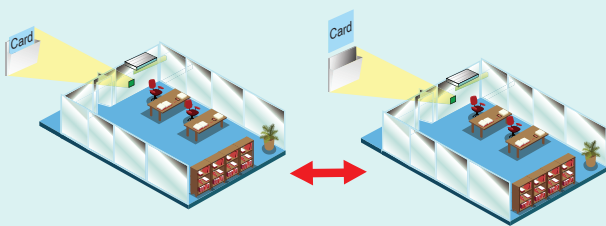

Mode 2

When entering the room, the user inserts the card to directly power on the air conditioning unit for operation. When leaving, the user unplugs the room card, and then the air conditioning unit powers off automatically.

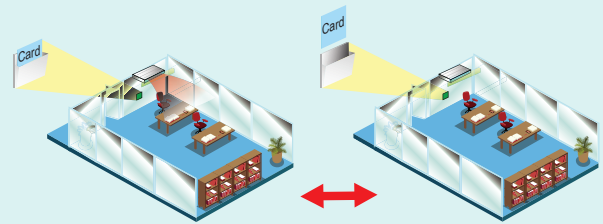

Mode 3

The smart room card interface can also implement multiple power-on/off functions, e.g., the external module can be used to power on/off the air conditioner through modes such as sound control or infrared sensing.

Refrigerant recovery of IDU

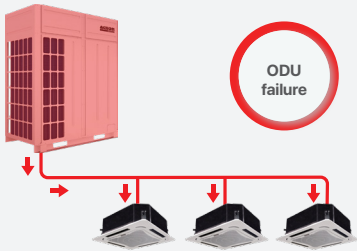

Refrigerant recovery of ODU



Recovery of Refrigerant

When the IDU, ODU or connection pipeline needs to be maintained, refrigerant is recovered through operation of the unit to reduce the waste of refrigerant and lower the maintenance cost.

System Restore

Should one of the indoor unit experience power failure, our system will bypass it and continue to operate. Once the power resume, the unit resume operation of prior setting just before the power failure.

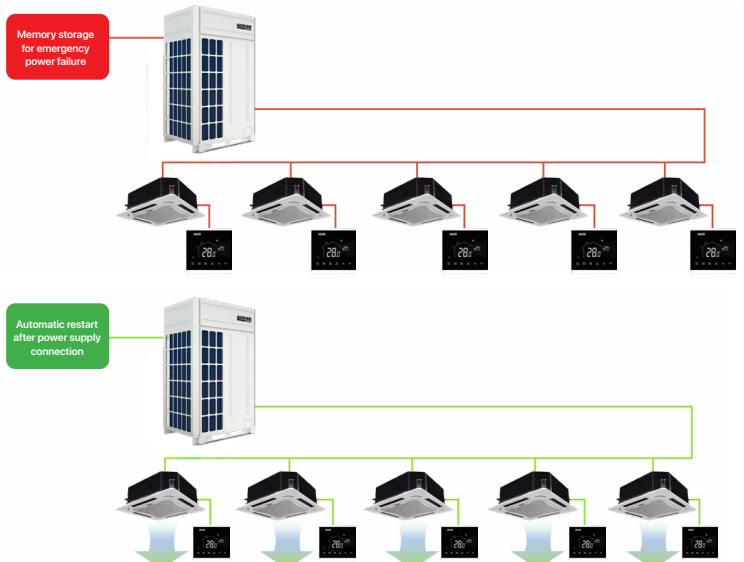
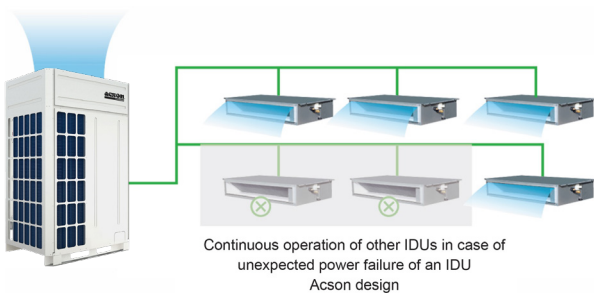

System Redundancy

Our AVR system uses a lot of sensors, switches, program logics and so on to provide a reliable system redundancy. This make our unit more resilient, a single component failure might not cause total failure. This enable user able to operate the system albeit not in full capacity while wait for the system to be rectified.



- 1 Compressor/fan overload protection
- 2 High/low pressure protection
- 3 Over-high temperature protection of air exhaust/return
- 4 Power protection
- 5 Inverter failure protection
- 6 Over-high/low ambient temperature protection
- 7 Refrigerant leakage protection

Compressor Backup Operation

For ODU with multiple compressor, the compressor can be operated separately. When any compressor fails, the other will still operate like normal.

Inter-module Redundancy Feature

For Alpha series, it is possible for a system to have multiple outdoor units (ODUs). When a module failed, the other module will still operate.

Fan Redundancy Feature

While for models with dual fan, either fan that are in operation is suffice for the system to continue its operation.



AVR Alpha Unique Features

Acson AVR Alpha is a versatile air-conditioning line-up that suit the most for commercial and industrial usage. It employs scroll compressors which are powerful and yet compact in size. It is the ideal choice for modern buildings as it can be integrated into the most diverse and inventive structures.

High Efficiency Inverter Scroll Compressor

Acson Inverter Variable Refrigerant Flow Alpha unit adopts high pressure chamber compressor with high performance and low sound level. In comparison to low pressure chamber scroll compressor, high chamber scroll compressor uses the asymmetric scroll design and a new generation inverter motor to provide brand-new air conditioner experience. The compressor boosts highly efficient operation, long service life, excellent stability, high efficiency, and low sound level.

Asymmetric Scroll

The scroll compressor enhances the high compression ratio heating application and increases energy efficiency at low load by using the variable compression ratio technology.

Radial Flexibility

It ensures the radial contact of the scroll and optimizes the radial sealing of the scroll. It allows for radial separation under poor operating conditions to prevent liquid or accessory damage to the compressor.

Oil Circulation

Adopt full lubrication of the bearing system and lower the rate of outer oil circulation.

High Pressure Chamber

Enhance compression performance and prevent motor overheating.

Positive Displacement Oil Pump

Supply oil to the bearing system reliably and control the rate of outer oil circulation.

Patented Oil Sealing Technology

This technology helps to reduce internal friction loss of the internal scroll and enhance the low speed sealing performance.

Dual-Segment Shell Structure

Higher shell stiffness to reduce on noise radiation.

Double Back Pressure Axial Flexibility

Ensure the axial contact of the scroll. Axial flexibility able to optimize the inter gear load and minimize the friction loss. It allows axial separation in difficult operating circumstances to avoid liquid or accessory damage to the compressor.

Magnet Motor

Enhance overall energy efficiency by using a centralized volume motor with patented rubidium magnet rotor.

Oil Balance Pipe

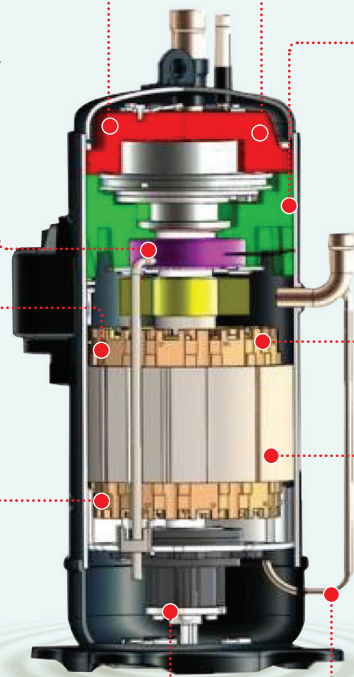

Asymmetric Scroll Design

The asymmetric scroll design implements dynamic continuous compression of refrigerant, efficiently reducing the leakage loss during compression and improving the operating efficiency and reliability of compressor.

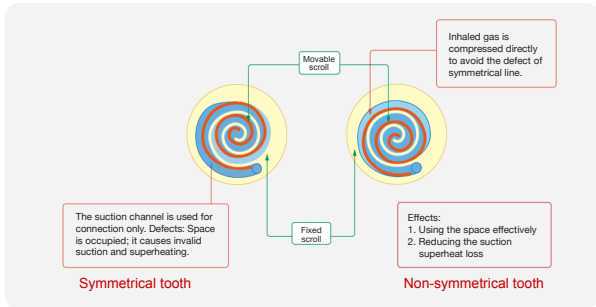

Thin Oil Film Lubrication Technology

The pressure differential between the dynamic and fixed scrolls is used to generate an oil film on contact surface, which reduces friction, operation noise, and mechanical loss. This in turn ensure better efficiency, stable operation and service life of the unit.

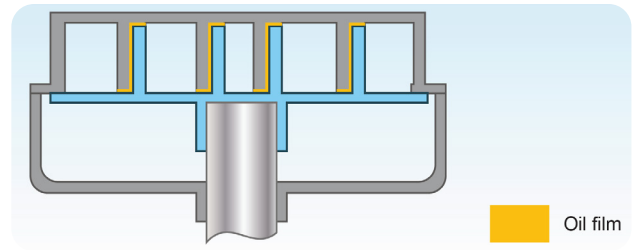

Compact Design

For modular design, Acson AVR require lesser foot print compare to most of the modular currently available. Making it an ideal choice for retrofit, replacement or applications that have minimal space for outdoor unit.

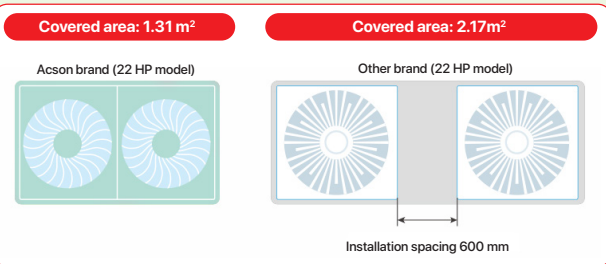

Outdoor Unit with Multiple Static

To further enhance its versatility, Alpha lineup can fitted with different motor (0/30/50/85 Pa). For tight spaces, the ODU discharge air can be directed to have a better ventilation and heat dissipation.

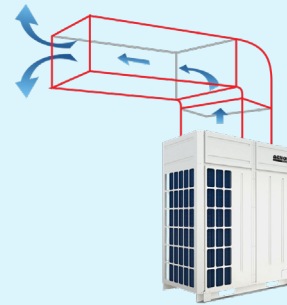

Efficient and Effective Refrigerant Path Design

The heat exchanger design is differ than conventional design, so that it able to cool the high temperature faster and more liquid refrigerant is distributed throughout the system.

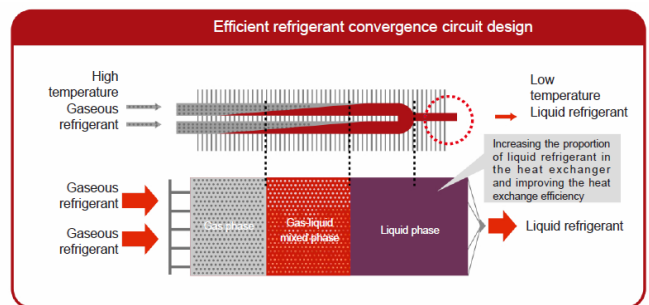
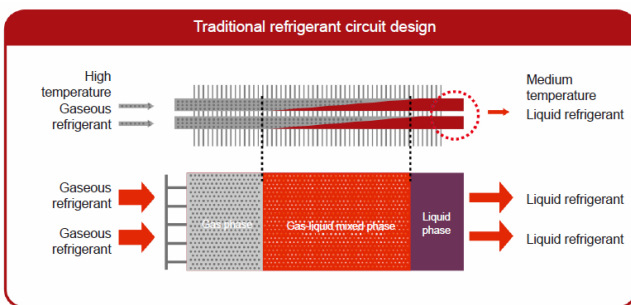

3 Supercool Stages

The equipment used in Alpha is more sophisticated due to the scale of cooling capacity of the unit.

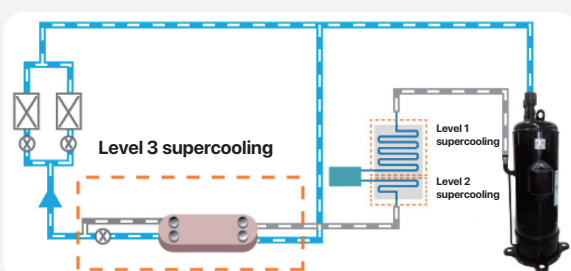

The stainless steel brazed plate heat exchanger has a small volume, and the internal heat exchange groove can strengthen the turbulent flow Of heat exchange greatly and ensure small heat loss of heat exchange and higher heat exchange efficiency under the same area.



Acson three-level supercooling part

System Rotation & Redundancy

One of the advantages of having multiple module is it is possible for the system to rotate between each module and compressor. By operating the least operating unit, we can extend the service life of the entire system and enhancing the reliability of the system.

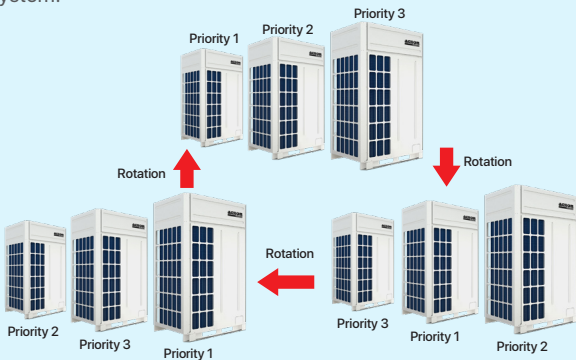





Emergency Stop

One of the criteria that need to be put into consideration during a building design is its emergency operations or procedure. Our unit have a dry contact for any emergency system to halt the operations of the unit in the event of emergency and avoid catastrophic losses.

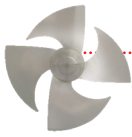

Noise Reducing Agent

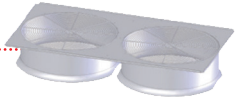
-  New scroll steamline fan blade
-  DC inverter fan motor
-  Large-capacity efficient DC inverter compressor
- Special damping gasket for compressor
- Multiple soundproof covers for each compressor package

-  Air Outlet grille with low noises
- Silent guide ring design
- CFD air flow analysis simulation
-  Night silent mode
- All-day silent mode
-  Three-dimensional pipeline optimized simulation design to avoid pipeline resonance and reduce noises of refrigerant flow
- Reduce noises during refrigerant flow

Smart Control Board

Few technological advancement made by our R&D team is the latest model utilize the new AIT intelligent control board. It incorporates circuit optimization, control logic updates, VRF unit control, fault display, debugging, anti-surge protection and much more.

Load Setting

It is now possible to operate the unit at a said capacity ranging from 60 ~ 100 (5 steps). Should the unit, draw more energy than the setting. The unit will trip in full-load operation, and effectively affecting the operation of the whole system.

Control System

One of the advantages of Acson AVR line-up is it use common control system. Thus, this make the system is more user friendly especially for future upgrades.

Independent Controller

Acson provides a big variety of independent controllers, including fashionable touch-screen wired controllers and practical and nice-looking wireless remote controllers. All of them can help you easily control the air conditioning unit and bring you more convenient and comfortable life with easy operations.



Wired Controller AC321 feature:

- | | | | |
|------------------------|----------------------------------|--|---|
| ① Temperature settings | ⑤ Keyboard locking and unlocking | ⑨ Timed power-on/off | ⑬ Real-time clock settings |
| ② Mode settings | ⑥ Fan speed settings | ⑩ Filter cleaning reminder | ⑭ Setting automatic startup after power restoration |
| ③ Sleep mode | ⑦ IDU address display | ⑪ Control function of auxiliary heater | ⑮ Weekly timed operation |
| ④ Failure code display | ⑧ Indoor temperature display | ⑫ °C/°F temperature settings | |

Centralized Controller AC-HMI323A

The centralized wired controller collects advantages of the convenient independent controller and the group-controlled centralized control system to perform centralized control on a single or multiple units. With rich functions and flexible applications, the centralized wired controller can widely apply to small- and medium-sized offices and business spaces.

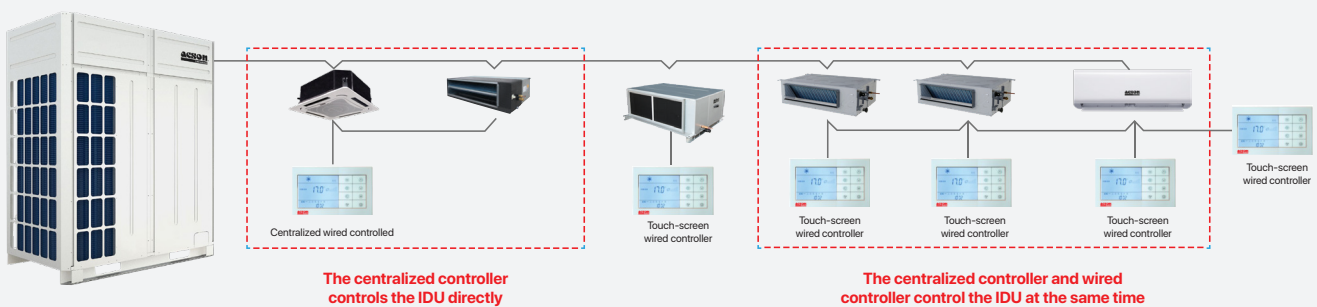

Control over a maximum of 64 IDUs

- | | | |
|---|--|--------------------------|
| ① Single control or group control (power-on/off, mode settings, parameter settings) | ⑤ Temperature unit settings | ⑨ Circulating display |
| ② Indoor temperature query | ⑥ Upper and lower room temperature limit query | ⑩ Real-time clock |
| ③ IDU locking | ⑦ Filter cleaning reminder | ⑪ Sleep mode |
| ④ Grouping | ⑧ Timed power-on/off | ⑫ Weekly timed operation |

Intelligent Monitoring System AC-CCS101A

Acson intelligent monitoring system can perform intelligent monitoring on multiple units with powerful functions. Featuring attractive monitoring interface and convenient control, the system can help proprietors to easily improve management efficiency. It is the first choice for large-sized and high-end offices and business places.

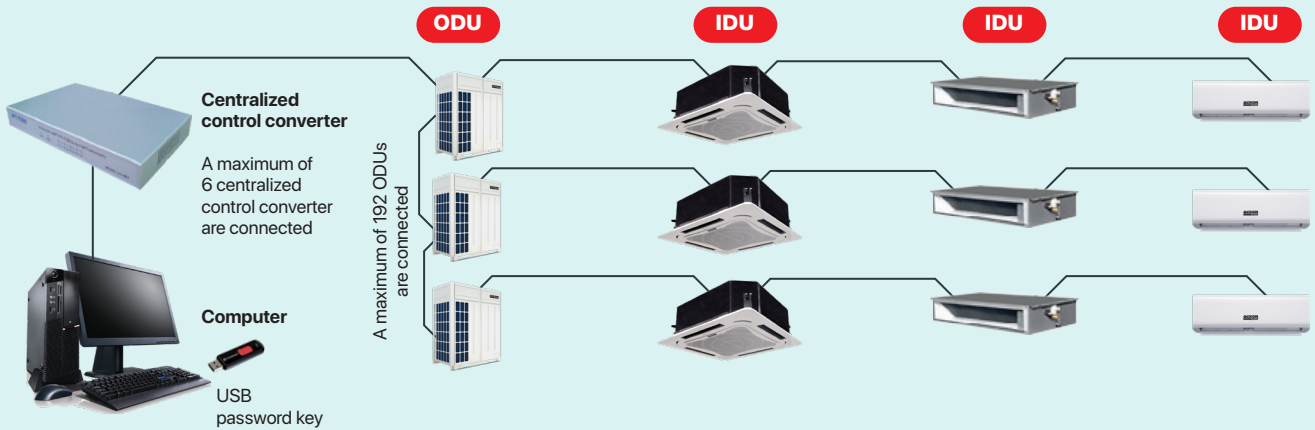

The system can perform centralized monitoring on multiple IDUs and ODUs from a remote end. A computer can be connected with a centralized control converter to perform network control on up to 192 ODUs and 3072 IDUs.

Features

Sets the IDU mode and wind speed, auxiliary settings, temperature and power on/off (multiple units or machines in multiple units can be selected to perform operations at the same time)

Centralized power-on/off (group control and control of a single IDU can be implemented)

Week or date settings

The historical operating status and operating parameters of multiple IDUs or ODUs and the unit operating data in the historical time segment can be queried, and the operating record report can be exported

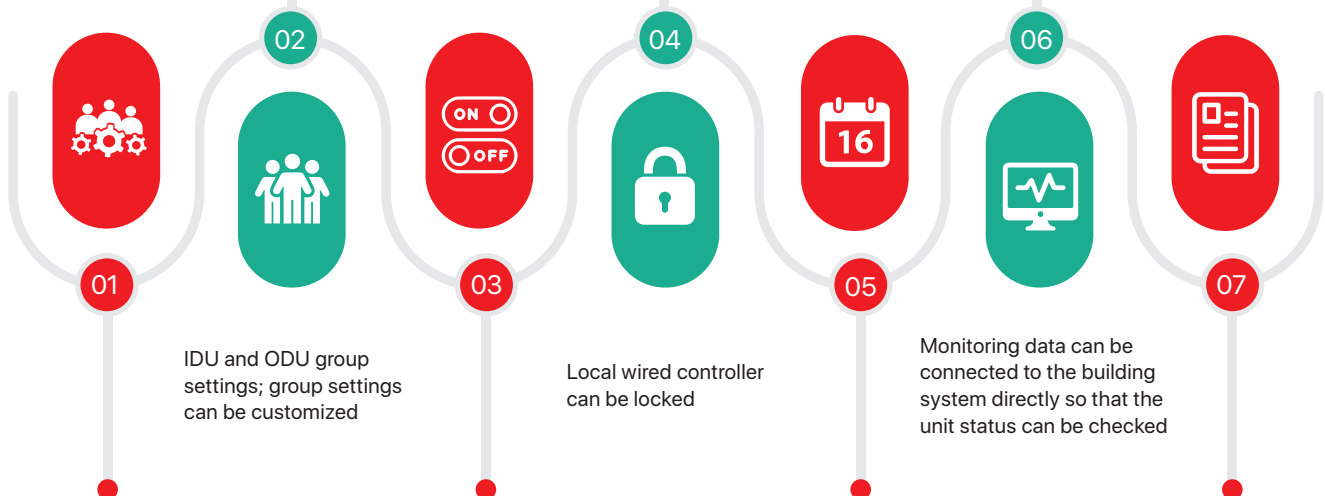

Building Automation System

Acson provides flexible building system control solutions:

The unit can be directly connected to the ModBus-based building automation system through the standard ModBus communication interface configured for the unit, implementing intelligent monitoring without accessing the conversion equipment.



The unit can be connected to the BACnet based building automation system through the BACnet gateway. A maximum of 24 ODUs can be connected to a BACnet gateway and up to 1536 IDUs can be connected at one time.

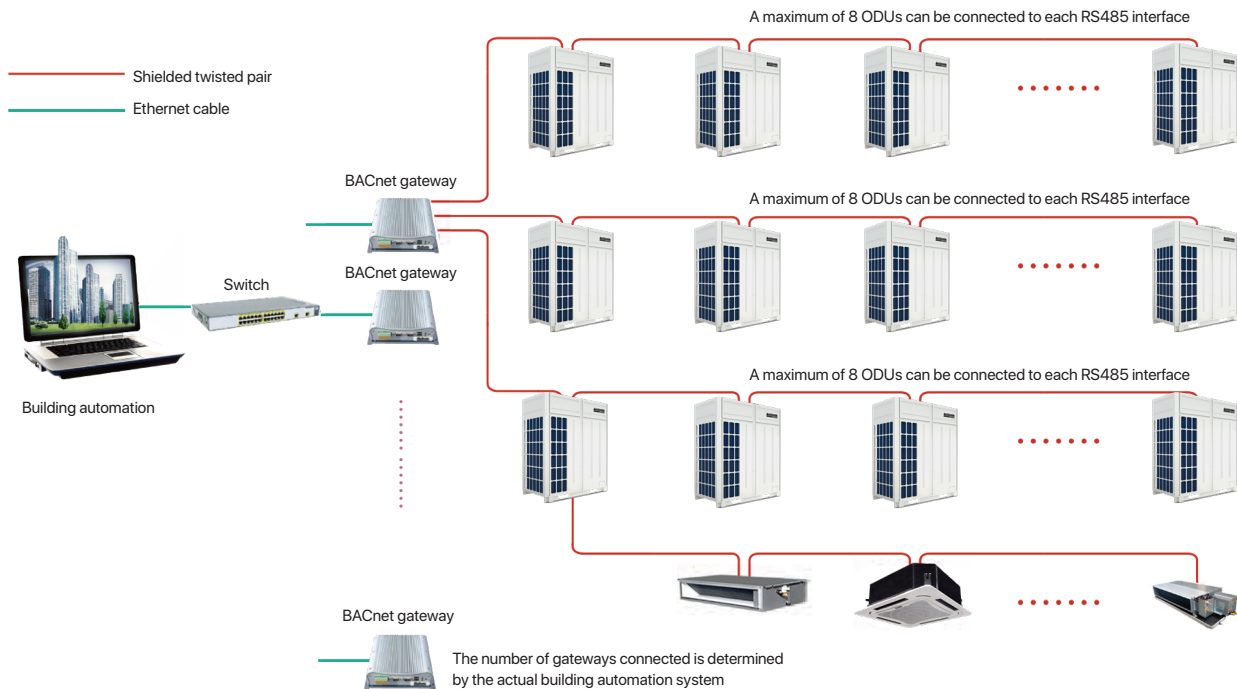



Model:
A5VWM022SP ~ A5VWM056SP

Nominal Cooling Capacity:
2.2kW ~ 5.6kW
7,500 BTU/h ~ 19,100 BTU/h

Wall Mounted IDU A5VWM-SP

Ultra-Thin Body Design

The thickness of multiple models is only 200mm, which can be installed conveniently. The beautiful appearance of the unit improves the indoor decorative style.

Swing Design

Guide blades can automatically swing up and down to achieve the good air supply status. The peak air supply mode can also be set by remote control to supply comfortable air everywhere in the room.



Simple and Flexible Installation

The unit can be easily installed with built-in electronic expansion valves. The connection direction of refrigerant pipes can be flexibly selected as actually required.

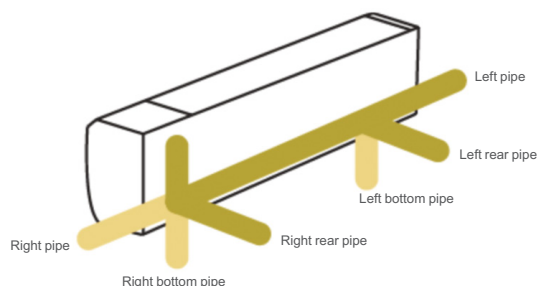

Super Silent Design

The IDUs use large diameter non-isometric helical through-flow wind wheels and excellent plastic covering motors to enable the unit to run more stably and smoothly. The advanced airflow analysis CFD is used to optimize air paths, making the air supply smoother and wind sound softer.

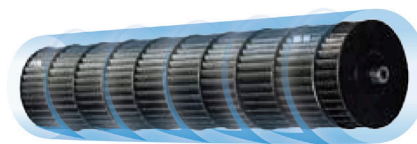

Cold Wind Prevention Design To Provide Comfortable Experience During Heating Operation

The units automatically start the cold wind prevention function when heating is started, to prevent discomfort caused by cold wind.

Ease Of Maintenance And Overhaul

The baffles of the units can be easily removed for regular cleaning and maintenance, saving your time.

Specifications

AVR Wall Mounted A5VWM-SP Series

Model		A5VWM022SP	A5VWM028SP	A5VWM036SP	A5VWM045SP	A5VWM056SP
Nominal Cooling Capacity	BTU/h	7,500	9,600	12,300	15,400	19,100
	kW	2.2	2.8	3.6	4.5	5.6
Input Power	kW	0.025		0.03	0.04	0.048
Power Supply		220-240V/50Hz				
Rated Input Current	A	0.18		0.2	0.28	
Noise	(High/Med/Low/ Ultra-Low) dB(A)	34/33/32/30		37/36/35/33	38/37/36/33	43/42/41/38
Air Flow Rate	Ultra-Low	m ³ /h / CFM	320 / 188.3	390 / 229.5	450 / 264.8	610 / 359.0
	Low	m ³ /h / CFM	380 / 223.6	430 / 253.0	530 / 311.9	680 / 400.2
	Medium	m ³ /h / CFM	400 / 235.4	480 / 282.5	570 / 335.4	750 / 441.4
	High	m ³ /h / CFM	430 / 253.0	500 / 294.2	610 / 359.0	800 / 470.8
Liquid Pipe Size	mm (in)	Φ 6.35(1/4")				
Gas Pipe Size	mm (in)	Φ 9.52(3/8")		Φ 12.7(1/2")		
Condensate Water Pipe Size	mm	Φ 20				
Unit Dimension	Width	mm	864		972	
	Depth	mm	200		215	
	Height	mm	300		320	
Packing Dimension	Width	mm	894		1007	
	Depth	mm	230		250	
	Height	mm	325		350	
Unit Weight	kg	9.5		12.5		
Gross Weight	kg	12		15		

Notes:

- The above cooling capacities are tested under the condition in which the indoor dry/wet bulb temperature is 27° C /19° C and the outdoor dry/wet bulb temperature is 35° C /24° C .
- The above parameters may be changed due to product improvement. The parameters indicated on the unit nameplate should prevail.



Ceiling Cassette IDU A5VCK-VP

Milky White Panel & Streamlined Design

This IDU adopts the milky white panel and streamlined design to guarantee that the ceiling around the unit is clean.

360° Directions Air Supply

Unique round flow air supply design can greatly expand the air supply range and supply soft air everywhere in the room.



Fresh Air Design

The standard configuration of the unit provides the long acting dust filter screen. Meanwhile, the fresh activated-carbon filter assembly is optional to filter dust particles from the air efficiently and remove the peculiar smell and odor. The filter screen can be removed and cleaned conveniently to keep the indoor air clean.

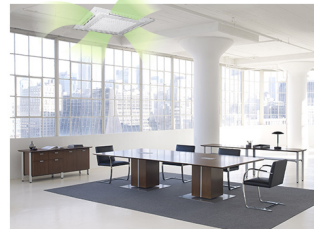

*Booster fan is required for fresh air specification. Please contact us for more information.

Smooth Drainage

The standard unit is configured with the condensate water lifting pump with the head being 700 mm to facilitate setting of drain pipes greatly.

Note: The 1200 mm condensate water pump is optional.



Introduction of Fresh Air

The unit is configured with a reserved fresh air inlet hole to introduce outdoor fresh air to the room and ensure a natural environment for the user.

Model:
A5VCK028VP ~ A5VCK140VP

Nominal Cooling Capacity:
2.8 kW ~ 14 kW
9,600 BTU/h ~ 47,800 BTU/h

Specifications

AVR Ceiling Cassette A5VCK-VP Series



Model			A5VCK028VP	A5VCK032VP	A5VCK036VP	A5VCK040VP	A5VCK045VP	A5VCK050VP	A5VCK056VP	A5VCK063VP	
Nominal	Cooling Capacity	BTU/hr	9,600	10,900	12,300	13,600	15,400	17,100	19,100	21,500	
		kW	2.8	3.2	3.6	4.0	4.5	5.0	5.6	6.3	
	Input Power	kW	0.040			0.048			0.065		
	Operating Current	A	0.19			0.22			0.31		
Control	Air Discharge		CIRCULAR AIR DISCHARGE								
Power Source		V/Ph/Hz	220 ~ 240V/~50Hz								
Air Flow Rate	High	m ³ /h / CFM	650 / 382		670 / 394		800 / 470		1,000 / 588		
	Medium		530 / 312			650 / 382		660 / 388		820 / 482	
	Low		440 / 259		540 / 318		550 / 323		690 / 406		
Sound Pressure Level	High	dB(A)	29			31			36		
	Medium		27								
	Low		25			24			28		
Unit Dimension (Without Panel)	Height	mm (in)	277 / 10.9"								
	Width	mm (in)	845 / 33.2"								
	Depth	mm (in)	845 / 33.2"								
Unit Weight (Excluding Panel Weight)		kg/lb	24 / 52.9				26 / 57.3				
Panel Dimensions	Height	mm (in)	57 / 2.24"								
	Width	mm (in)	950 / 37.40"								
	Depth	mm (in)	950 / 37.40"								
Panel Weight		kg / lb	5 / 11								
Drainage Pipe Size		mm (in)	20.5 (4/5")								
Piping	Discharge	mm (in)	6.35 (1/4")								
	Suction	mm (in)	9.52 (3/8")	12.7 (1/2")						15.88 (5/8")	

Model			A5VCK071VP	A5VCK080VP	A5VCK090VP	A5VCK100VP	A5VCK112VP	A5VCK125VP	A5VCK140VP	
Nominal	Cooling Capacity	BTU/hr	24,200	27,300	30,700	34,100	38,200	42,700	47,800	
		kW	7.1	8.0	9.0	10.0	11.2	12.5	14.0	
	Input Power	kW	0.074			0.083	0.108	0.142		0.182
	Operating Current	A	0.35			0.39	0.50	0.66		0.84
Control	Air Discharge		CIRCULAR AIR DISCHARGE							
Power Source		V/Ph/Hz	220 ~ 240V/~50Hz							
Air Flow Rate	High	m ³ /h / CFM	1,100 / 647	1,120 / 659	1,200 / 706	1,300 / 765	1,600 / 940		1,800 / 1059	
	Medium		890 / 524	900 / 530	990 / 582	1,070 / 630		1,230 / 724	1,480 / 871	
	Low		740 / 435	750 / 441	800 / 471	850 / 500		1,050 / 618	1,150 / 677	
Sound Pressure Level	High	dB(A)	40		41	42	47	50	51	
	Medium		34		36	37	43	45	48	
	Low		29		32	33	37	41	45	
Unit Dimension (Without Panel)	Height	mm (in)	277 / 10.9"			315 / 12.4"				
	Width	mm (in)	845 / 33.2"							
	Depth	mm (in)	845 / 33.2"							
Unit Weight (Excluding Panel Weight)		kg/lb	26			29			31	
Panel Dimensions	Height	mm (in)	57 / 2.24							
	Width	mm (in)	950 / 37.40							
	Depth	mm (in)	950 / 37.40							
Panel Weight		kg / lb	5 / 11							
Drainage Pipe Size		mm (in)	20.5 (4/5")							
Piping	Discharge	mm (in)	9.52 (3/8")							
	Suction	mm (in)	15.88 (5/8")							

Notes:

1. Nominal cooling capacity are based on the conditions below:

Cooling	
Indoor	27°C DB / 19° C WB
Outdoor	35°C DB / 24° C WB

2. Sound pressure level is measured in a semi-anechoic chamber. Actual noise level might be higher due to external influence.

3. Unit in parentheses is available external static pressure. Please contact us for more details.

4. All specifications are subjected to change by the manufacturer without prior notice.

Standard Ceiling Concealed IDU A5VCC-E

Standard Concealed Design

With a thickness of 198mm and depth of 450mm only, the unit can flexibly apply to the narrow and small installation environment, thus creating more comfortable spaces.

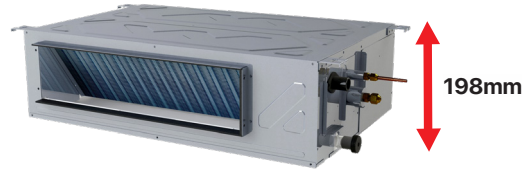

Model:

A5VCC022E ~ A5VCC071E

Nominal Cooling Capacity:

2.2 kW ~ 7.1 kW

7,500 BTU/h ~ 24,200 BTU/h

Integrated Design

The unit provides the built-in electronic expansion valve and the condensate water lifting pump with the lift being 700 mm to save more ceiling height and enable smoother drainage.



Flexible Air Return Mode

The standard unit adopts the back air return mode, which can be converted to bottom air return by moving a movable plate on the installation site. The back air return mode is superior to the bottom air return mode in noises.

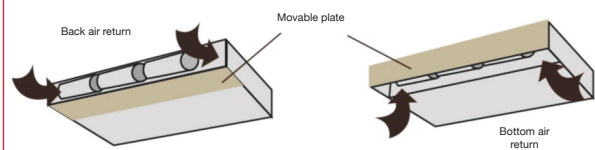

Note: The noise of bottom air return is about 5 dB(A) higher than that of the back air return mode.

Specifications

AVR Ceiling Concealed A5VCC-E (Standard Series)

Model			A5VCC022E	A5VCC025E	A5VCC028E	A5VCC032E	A5VCC036E
Nominal	Cooling Capacity	BTU/h	7,500	8,500	9,500	10,900	12,200
		kW	2.2	2.5	2.8	3.2	3.6
	Input Power	kW	0.051			0.056	
	Operating Current	A	0.25			0.27	
Control	Operation		WIRED CONTROLLER (WIRELESS OPTIONAL)				
Power Source	V/Ph/Hz		220 ~ 240V/~ /50Hz				
Refrigerant Control			BUILT - IN ELECTRONIC EXPANSION VALVE				
Air Flow Rate	m³/h		520 / 450 / 380 / 300 / 250			620 / 550 / 450 / 400 / 330	
	CFM		306 / 264 / 223 / 176 / 147			365 / 323 / 264 / 235 / 194	
External Static Pressure	Pa		10 (0/30)				
	in.wg		0.04 (0/0.12)				
Sound Pressure Level	dB(A)		31 / 28 / 27 / 25 / 24			34 / 32 / 28 / 26 / 25	
Unit Dimension	Height	mm(in)	198 (7.80")				
	Width	mm(in)	700 (27.56")				
	Depth	mm(in)	450 (17.72)				
Unit Weight	kg/lb		16.0 / 35.3				
Drainage Pipe Size	mm(in)		20.5 (4/5")				
Piping	Discharge	mm(in)	6.35 (1/4")				
	Suction	mm(in)	9.52 (3/8")			12.70 (1/2")	

Model			A5VCC040E	A5VCC045E	A5VCC050E	A5VCC056E	A5VCC063E	A5VCC071E	
Nominal	Cooling Capacity	BTU/h	13,600	15,300	17,000	19,100	21,400	24,200	
		kW	4.0	4.5	5.0	5.6	6.3	7.1	
	Input Power	kW	0.071			0.091		0.107	
	Operating Current	A	0.35			0.44		0.5	
Control	Operation		WIRED CONTROLLER (WIRELESS OPTIONAL)						
Power Source	V/Ph/Hz		220 ~ 240V/~ /50Hz						
Refrigerant Control			BUILT - IN ELECTRONIC EXPANSION VALVE						
Air Flow Rate	m³/h		680 / 620 / 520 / 440 / 400			820 / 800 / 680 / 570 / 520		1,050 / 1,000 / 830 / 690 / 600	1,160 / 1,100 / 910 / 750 / 660
	CFM		400 / 365 / 306 / 259 / 235			482 / 470 / 400 / 335 / 306		618 / 588 / 488 / 406 / 353	682 / 647 / 535 / 441 / 388
External Static Pressure	Pa		10 (0/30)						
	in.wg		0.04 (0/0.12)						
Sound Pressure Level	dB(A)		36 / 34 / 30 / 28 / 26			37 / 36 / 34 / 33 / 31		37 / 36 / 33 / 31 / 30	38 / 37 / 34 / 32 / 30
Unit Dimension	Height	mm(in)	198 (7.80")						
	Width	mm(in)	700 (27.56")			900 (35.43")		1150 (45.28")	
	Depth	mm(in)	450 (17.72)						
Unit Weight	kg/lb		16.0 / 35.3			20.0 / 44.1		24.5 / 54.0	
Drainage Pipe Size	mm(in)		20.5 (4/5")						
Piping	Discharge	mm(in)	6.35 (1/4")						
	Suction	mm(in)	12.70 (1/2")				15.88 (5/8")		

Notes:

1. Nominal cooling capacity are based on the conditions below:

Cooling	
Indoor	27°C DB / 19° C WB
Outdoor	35°C DB / 24° C WB

2. Sound pressure level is measured in a semi-anechoic chamber. Actual noise level might be higher due to external influence.

3. Unit in parentheses is available external static pressure. Please contact us for more details.

4. All specifications are subjected to change by the manufacturer without prior notice.

Compact Ceiling Concealed IDU A5VCC-V

Silence and Low Noise

The IDU adopts the centrifugal double-suction fan featuring high-efficiency wide-impeller and forward-curved multi-blade to implement low speed, large air volume and low noise.

Onsite Regulation For Multiple Static

The IDU is configured with multiple external static pressures such as 15/30/50Pa based on cooling capacity to flexibly set air ducts at different air supply distances. Static pressures can be converted by changing motor wire connection to easily meet air supply requirements in different situations.

High-Lift Condensate Water Lifting Pump

The unit can be configured with the condensate water lifting pump with a high lift to facilitate field installation and effectively drain off the condensate water from the air conditioning system.



Model:
A5VCC080V ~ A5VCC160V

Nominal Cooling Capacity:
8.0kW ~ 16.0kW
27,300BTU/h ~ 54,600BTU/h

Specifications

AVR Ceiling Concealed A5VCC-V (Compact) Series



Model			A5VCC080V	A5VCC090V	A5VCC100V	A5VCC112V	A5VCC125V	A5VCC140V	A5VCC160V
Nominal	Cooling Capacity	BTU/h	27,300	30,700	34,100	38,200	42,700	47,800	54,600
		kW	8.00	9.00	10.00	11.20	12.50	14.00	16.00
	Input Power	kW	0.184	0.235	0.295	0.295	0.322	0.39	0.41
	Operating Current	A	0.86	1.13	1.4	1.4	1.55	1.85	1.95
Control	Operation		WIRED CONTROLLER (WIRELESS: OPTIONAL)						
Power Source		V/Ph/Hz	220 ~ 240V/~50Hz						
Refrigerant Control			BUILT - IN ELECTRONIC EXPANSION VALVE						
Air Flow Rate	Low	m ³ /h / CFM	840 / 494	980 / 577	1,100 / 647	1,130 / 665	1,290 / 759	1,520 / 895	1,540 / 906
	Medium	m ³ /h / CFM	950 / 559	1,200 / 706	1,370 / 806	1,380 / 812	1,530 / 901	1,830 / 1,077	1,900 / 1,118
	High	m ³ /h / CFM	1,200 / 706	1,400 / 824	1,680 / 989	1,700 / 1,001	1,900 / 1,118	2,200 / 1,295	2,300 / 1,354
External Static Pressure		Pa	50 (30/80)						
		in.wg	0.2 (0.12/0.32)						
Sound Pressure Level		dB(A)	36 / 37 / 40	38 / 40 / 41	41 / 40 / 38	42 / 38 / 36	43 / 40 / 38	45 / 44 / 40	45 / 44 / 41
Unit Dimension	Height	mm(in)	300 (11.81)						
	Width	mm(in)	1,150 (45.28)			1,450 (57.09)			
	Depth	mm(in)	600 (23.62)						
Packing Dimension	Height	mm(in)	320 (12.6)						
	Width	mm(in)	1,320 (51.97)			1,620 (63.78)			
	Depth	mm(in)	670 (23.38)						
Unit Weight		kg / lb	38 / 84			48 / 106			
Drainage Pipe Size		mm(in)	19.05 (R3/4)						
Piping	Discharge	mm(in)	9.52 (3/8")						
	Suction	mm(in)	15.88(5/8")						

Notes:

1. Nominal cooling capacity are based on the conditions below:

Cooling	
Indoor	27°C DB / 19° C WB
Outdoor	35°C DB / 24° C WB

2. Sound pressure level is measured in a semi-anechoic chamber. Actual noise level might be higher due to external influence.

3. Unit in parentheses is available external static pressure. Please contact us for more details.

4. All specifications are subjected to change by the manufacturer without prior notice.

High Static Ducted Blower IDU A5VDB-X

Various Design of Air Outlets

Various types of air outlets can be used to match different types of decoration styles.



Round Diffuser



Swirling Air Outlet



Square Diffuser



Bar Type Air Outlet

Model:

A5VDB224X - A5VDB280X

Nominal Cooling Capacity:

22.4 kW ~ 28 kW

76,400 BTU/h ~ 95,500 BTU/h

Slim Design

With the ultra-thin body design, the unit can be mounted on the ceiling to save the construction space and cost.

Elegant Decoration

The IDU and air duct are installed inside the ceiling like the large-scale central air conditioning system. After installation, the air outlets are well integrated with the indoor decoration.

Free Placement Of Air Ducts

With the standard high static pressure of air supply, air ducts can be made more flexibly to match various air outlets and meet requirements in different types of rooms.

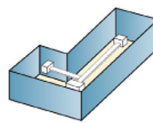

L-shaped room

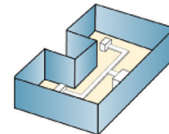

U-shaped room

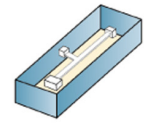

Narrow and long room

Comfortable Air Supply

The unit supplies cold to each area through air ducts. The air outlet can flexibly adopt side air supply or bottom air supply according to actual situations to supply even and comfortable air flow.

Side air supply

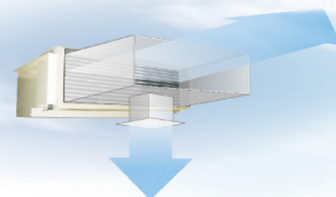

Bottom air supply

Specifications

AVR Ducted Blower A5VDB-X Series

Model			A5VDB224X	A5VDB280X
Nominal	Cooling Capacity	BTU/h	76,400	95,500
		kW	22.4	28.0
Power Source		V/Ph/Hz	380-415V/3N~/50Hz	
Rated Input Current		A	2.05	2.75
Total External Pressure		Pa	225	300
Air Flow	m ³ /h		4,000	5,000
	CFM		2,354	2,942
External Static Pressure		Pa	175	225
Motor Power		kW	1.1	1.5
Motor Rated Input Power		kW	1.35	1.81
Air Filter			Nylon Filter	
Drainage Pipe Size		mm(in)	25.4 (R1)	
Piping	Discharge	mm(in)	9.52 (3/8")	12.70 (1/2")
	Suction	mm(in)	19.05 (3/4")	22.23 (7/8")
Unit Dimension	Height	mm(in)	498 (19.6)	
	Width	mm(in)	1,300 (51.2)	1,550 (61.0)
	Depth	mm(in)	870 (34.2)	
Unit Weight		kg	117	140

Notes:

1. Nominal cooling capacity are based on the conditions below:

Cooling	
Indoor	27°C DB / 19° C WB
Outdoor	35°C DB / 24° C WB

2. Sound pressure level is measured in a semi-anechoic chamber. Actual noise level might be higher due to external influence.

3. Unit in parentheses is available external static pressure. Please contact us for more details.

4. All specifications are subjected to change by the manufacturer without prior notice.



Specifications

A5VRY A Alpha Series



Model		A5VRY080A	A5VRY100A	A5VRY120A	A5VRY140A	A5VRY160A	A5VRY180A	A5VRY200A	A5VRY220A
Cooling Capacity	kW	25.20	28.00	33.50	40.50	45.00	50.40	56.00	61.50
	BTU/h	85,900	95,500	114,300	138,100	153,500	171,900	191,000	209,800
Nominal Input Power	kW	5.60	6.70	8.15	10.38	11.56	13.15	14.30	15.73
Nominal Operating Current	A	10.2	12.1	15.5	17.8	21.3	25.4	29.8	32.1
Efficiency	COP	W/W	4.5	4.18	4.11	3.9	3.89	3.83	3.92
Power Source	V/Ph/Hz	380-415V/3N~/50Hz							
Air Flow Rate	m³/h	9,700	10,600	14,000	14,000	14,700	14,700	22,000	22,000
	CFM	5,709	6,238	8,240	8,240	8,652	8,652	12,948	12,948
Noise	dB(A)	56	58	60	60	60	61	62	62
Unit Dimension (Individual)	Height	mm(in)	1,650 (64.96)						
	Width	mm(in)	950 (37.40)		1,340 (52.75)			1,680 (66.14)	
	Depth	mm(in)	780 (30.71)						
Packing Dimension (Individual)	Height	mm(in)	1,820 (71.65)						
	Width	mm(in)	1,000 (39.37)		1,390 (54.72)			1,730 (68.11)	
	Depth	mm(in)	830 (32.68)						
Unit Weight	kg/lb	220.0 / 485	221.0 / 487	259.5 / 572	262.0 / 577	310.5 (684.5)	326.5 (719.8)	449 (989.8)	
Maximum Indoor Unit	pcs	16			20		24		28
Refrigerant	Type	R410A							
	Charge	kg/lb	8.0 / 17.64		9.0 / 19.84	11.5 / 25.35	14 / 30.86		18 / 39.68
Connection Pipe	Discharge	mm(in)	9.52 (3/8)		12.70 (1/2)			15.88 (5/8)	
	Suction	mm(in)	22.23 (7/8)		28.60 (1-1/8)				

Notes:

1. Nominal cooling capacity are based on the conditions below:

Cooling		
Indoor	27°C DB / 19° C WB	
Outdoor	35°C DB / 24° C WB	
Pipe	Length	5m
	Height	0m (On Ground)

- Sound pressure level is measured in a semi-anechoic chamber. Actual noise level might be higher due to external influence.
- Multiple module installation will require additional accessory.
- All specifications are subjected to change by the manufacturer without prior notice.



Specifications

A5VRY A Alpha Series



Model		A5VRY240A	A5VRY260A	A5VRY280A	A5VRY300A	A5VRY320A	A5VRY340A	A5VRY360A	A5VRY380A		
Combination	Master	A5VRY100A	A5VRY100A	A5VRY100A	A5VRY140A	A5VRY140A	A5VRY160A	A5VRY180A	A5VRY160A		
	Slave	A5VRY140A	A5VRY160A	A5VRY180A	A5VRY160A	A5VRY180A	A5VRY180A	A5VRY180A	A5VRY220A		
	Slave										
Cooling Capacity	kW	68.50	73.00	78.40	85.50	90.90	95.40	100.80	106.50		
	BTU/h	233,700	249,000	267,500	291,700	310,100	325,500	343,900	363,300		
Nominal Input Power		kW	17.08	18.26	19.85	21.94	23.53	24.71	26.30	27.29	
Nominal Operating Current		A	29.9	33.4	37.5	39.1	43.2	46.7	50.8	53.4	
Efficiency	COP	W/W	4.01	4.00	3.95	3.9	3.86	3.86	3.83	3.9	
Power Source		V/Ph/Hz	380-415V/3N~/50Hz								
Air Flow Rate	m ³ /h		24,600	25,300	25,300	28,700	28,700	29,400	29,400	36,700	
	CFM		14,479	14,891	14,891	16,892	16,892	17,304	17,304	21,601	
Noise		dB(A)	62	62	63	63	64	64	64	64	
Unit Dimension (Individual)	Height	mm(in)	1,650 (64.96)								
	Width	mm(in)	2,290 (90.16)			2,680 (105.51)			3,020 (118.90)		
	Depth	mm (in)	780 (30.71)								
Packing Dimension (Individual)	Height	mm(in)	1,820 (71.65)								
	Width	mm(in)	2,390 (94.09)			2,780 (109.44)			3,120 (122.83)		
	Depth	mm(in)	830 (32.68)								
Unit Weight		kg/lb	483 / 1,064	531.5 / 1,171	547.5 / 1,207	572.5 / 1,262	588.5 / 1,297	637 / 1,404	653 / 1,439	759.5 / 1,674	
Maximum Indoor Unit		pcs	28	32		36		40		44	
Refrigerant	Type		R410A								
	Charge	kg/lb	19.5 / 42.99	22 / 48.5		25.5 / 56.2		28 / 61.7		32 / 70.5	
Connection Pipe	Discharge	mm(in)	15.88 (5/8")	19.05 (3/4")							
	Suction	mm(in)	28.6 (1-1/8")	31.8 (1-1/4")			34.9 (1-3/8")		38.1 (1-1/2")		

Notes:

1. Nominal cooling capacity are based on the conditions below:

Cooling		
Indoor	27°C DB / 19° C WB	
Outdoor	35°C DB / 24° C WB	
Pipe	Length	5m
	Height	0m (On Ground)



2. Sound pressure level is measured in a semi-anechoic chamber. Actual noise level might be higher due to external influence.

3. Multiple module installation will require additional accessory.

4. All specifications are subjected to change by the manufacturer without prior notice.



Specifications

A5VRY A Alpha Series



Model		A5VRY400A	A5VRY420A	A5VRY440A	A5VRY460A	A5VRY480A	A5VRY500A	A5VRY520A	A5VRY540A		
Combination	Master	A5VRY180A	A5VRY200A	A5VRY220A	A5VRY140A	A5VRY140A	A5VRY140A	A5VRY160A	A5VRY180A		
	Slave	A5VRY220A	A5VRY220A	A5VRY220A	A5VRY140A	A5VRY160A	A5VRY180A	A5VRY180A	A5VRY180A		
	Slave				A5VRY180A	A5VRY180A	A5VRY180A	A5VRY180A	A5VRY180A		
Cooling Capacity	kW	111.90	117.50	123.00	131.40	135.90	141.30	145.80	151.20		
	BTU/h	381,800	400,900	419,600	448,300	463,700	482,100	497,400	515,900		
Nominal Input Power		kW	28.88	30.03	31.46	33.91	35.09	36.68	37.88	39.45	
Nominal Operating Current		A	57.5	61.9	64.2	61	64.5	68.6	72.1	76.2	
Efficiency	COP	W/W	3.87	3.91	3.91	3.87	3.87	3.85	3.84	3.83	
Power Source		V/Ph/Hz	380-415V/3N~/50Hz								
Air Flow Rate	m ³ /h		36,700	44,000	44,000	42,700	43,400	43,400	44,100	44,100	
	CFM		21,601	25,897	25,897	25,132	25,544	25,544	25,956	25,956	
Noise		dB(A)	64	65			66				
Unit Dimension (Individual)	Height	mm(in)	1,650 (64.96)								
	Width	mm(in)	3,020 (118.90)	3,360 (132.28)			4,020 (158.27)				
	Depth	mm(in)	780 (30.71)								
Packing Dimension (Individual)	Height	mm(in)	1,820 (71.65)								
	Width	mm(in)	3,120 (122.83)	3,460 (136.22)			4,170 (164.17)				
	Depth	mm(in)	830 (32.68)								
Unit Weight		kg/lb	765.5 / 1,687	885 / 1,951		841 / 1,854	889 / 1,960	905 / 1,995	953 / 2,101	979.5 / 2,159	
Maximum Indoor Unit		pcs	44	48		52		54		56	
Refrigerant	Type		R410A								
	Charge	kg/lb	32 / 70.5	36 / 79.3		37 / 81.5		42 / 92.6			
Connection Pipe	Discharge	mm(in)	19.05 (3/4")								
	Suction	mm(in)	38.1 (1-1/2")								

Notes:

1. Nominal cooling capacity are based on the conditions below:

Cooling		
Indoor	27°C DB / 19° C WB	
Outdoor	35°C DB / 24° C WB	
Pipe	Length	5m
	Height	0m (On Ground)



2. Sound pressure level is measured in a semi-anechoic chamber. Actual noise level might be higher due to external influence.
3. Multiple module installation will require additional accessory.
4. All specifications are subjected to change by the manufacturer without prior notice.

Specifications

A5VRY A Alpha Series



Model		A5VRY560A	A5VRY580A	A5VRY600A	A5VRY620A	A5VRY640A	A5VRY660A	
Combination	Master	A5VRY160A	A5VRY180A	A5VRY160A	A5VRY180A	A5VRY200A	A5VRY220A	
	Slave	A5VRY180A	A5VRY180A	A5VRY220A	A5VRY220A	A5VRY220A	A5VRY220A	
	Slave	A5VRY220A	A5VRY220A	A5VRY220A	A5VRY220A	A5VRY220A	A5VRY220A	
Cooling Capacity	kW	156.90	162.30	168.00	173.40	179.00	184.50	
	BTU/h	535,300	553,700	573,200	591,600	610,700	629,500	
Nominal Input Power	kW	39.45	40.44	42.03	43.02	44.61	45.76	
Nominal Operating Current	A	78.8	82.9	85.5	89.6	94.0	96.3	
Efficiency	COP	W/W	3.97	4.01	3.99	4.03	4.01	4.03
Power Source	V/Ph/Hz	380-415V/3N~/50Hz						
Air Flow Rate	m ³ /h	51,400	51,400	58,700	58,700	66,000	66,000	
	CFM	30,253	30,253	34,550	34,550	38,846	38,846	
Noise	dB(A)	66				67		
Unit Dimension (Individual)	Height	1,650 (64.96)						
	Width	4,360 (171.65)		4,700 (185.04)		5,040 (198.43)		
	Depth	780 (30.71)						
Packing Dimension (Individual)	Height	1,820 (71.65)						
	Width	4,510 (177.56)		4,850 (190.94)		5,190 (204.33)		
	Depth	830 (32.68)						
Unit Weight	kg/lb	1,086 / 2,394	1,102 / 2,429	1,208.5 / 2,664	1,224.5 / 2,699	1,347 / 2,969		
Maximum Indoor Unit	pcs	58			60			
Refrigerant	Type	R410A						
	Charge	46 / 101		50 / 110		54 / 119		
Connection Pipe	Discharge	22.23 (7/8")						
	Suction	44.5 (1-3/4")						

Notes:

1. Nominal cooling capacity are based on the conditions below:

Cooling		
Indoor	27°C DB / 19° C WB	
Outdoor	35°C DB / 24° C WB	
Pipe	Length	5m
	Height	0m (On Ground)



- Sound pressure level is measured in a semi-anechoic chamber. Actual noise level might be higher due to external influence.
- Multiple module installation will require additional accessory.
- All specifications are subjected to change by the manufacturer without prior notice.



Accessories Kit

Indoor Unit

LCD Wired Controller	LCD Wireless Controller	Condensate Water Lifting Pump
		 700 mm lift available

Controller

Optional Accessories for Separate Controllers

No.	Order Code	Name	Model	Applicable Model
1	AC-HMI328AE	Wired Controller	AC328A	All IDUs and Fresh air IDU
2	AC-HMIGS01CE-(1/10/50)A	Wireless remote controller (including remote receiver)	AC S01	All IDUs and Fresh air IDU
3	AC-HMIGS01DE-(1/10/50)A	Wireless remote controller (excluding remote receiver)	AC S01	A5VWM/A5VCK

Note: * (1/10/50) indicates the number of controllers accommodated in single package box.

* A/B/C indicates white, blue, and gold respectively.

For details, see the order naming list.



System Control - Centralized Management System

Control mode	Centralized wired controller	Centralized monitoring system	Household-based billing system	Building automation
Ordered parts	AC-HMI323A	AC-CCS101A (centralized monitoring software) AC-GTW001A (1-channel conversion interface) AC-GTW001 B (4-channel conversion interface)	AC-CCS102A (software system) AC-GTW002A (power divider) AC-GTW002B (data backup device)	Does not need to order ModBus gateway (Built-In) AC-GTW003A (BACNET protocol gateway)

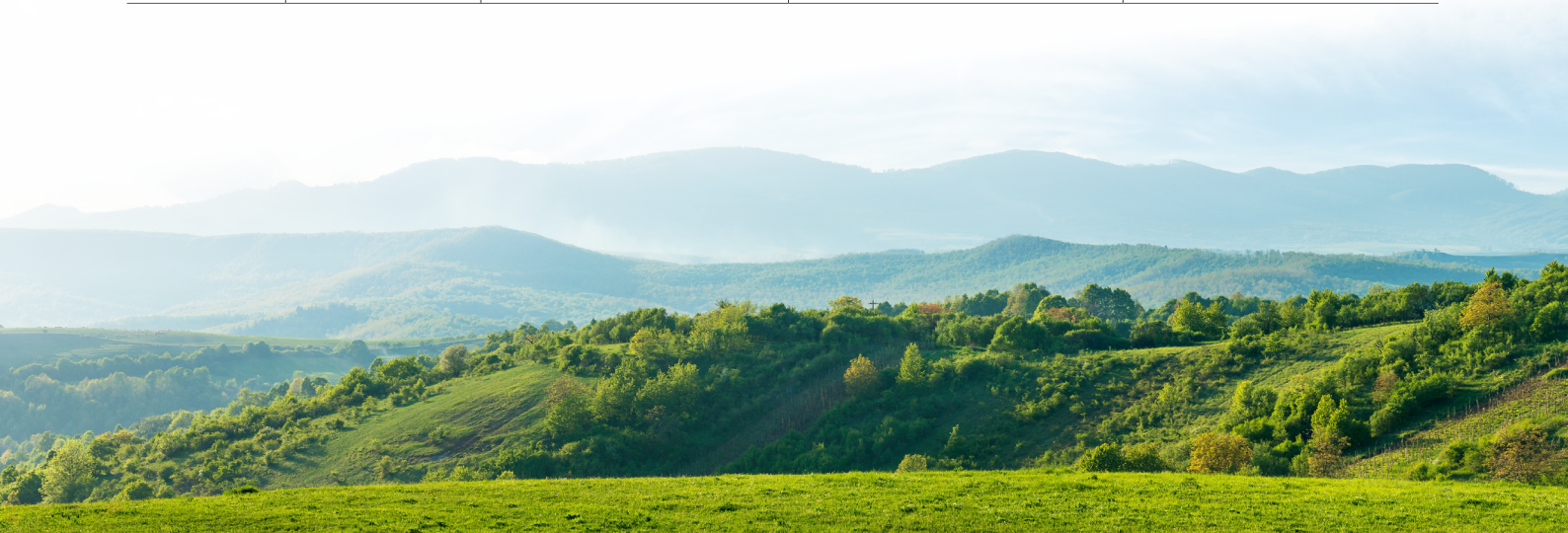

Piping Overview

The Alpha series VRF units optimize the supercooling design and refrigerant control technologies and break through limitations in the pipe connection, which give larger product design and construction space and allow for more flexible deployment of ODUs.

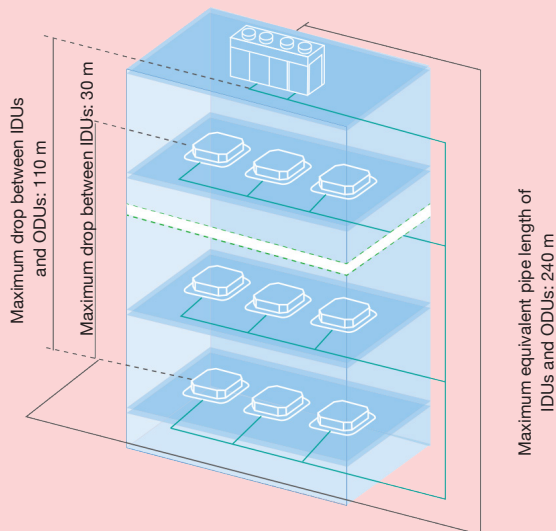

For items marked with *, please consult for details.

240m

Maximum equivalent single pipe length:

1,000m

Total pipe length:

30m

Maximum height difference between IDUs:

110m

Maximum height difference between IDUs and ODUs when ODUs are installed above IDUs:

90m*

Maximum distance between the first refnet and furthest IDU:

Summary-Indoor & Outdoor Unit Line-up

Indoor Unit Line-up

Model		Capacity range (kW)	2.2	2.5	2.8	2.2	3.6	4.0	4.5	5.0	5.6	6.3	7.1	8.0	9.0	10.0	11.2	12.5	14.0	16.0	22.4	28	
IDU	Ceiling Concealed (Standard) A5VCC-E		✓	✓	✓	✓	✓	✓	✓	✓	✓	✓	✓										
	Ceiling Concealed (Compact) A5VCC-V													✓	✓	✓	✓	✓	✓	✓			
	Ceiling Cassette A5VCK-VP				✓	✓	✓	✓	✓	✓	✓	✓	✓	✓	✓	✓	✓	✓	✓	✓			
	Ducted Blower A5VDB-X																					✓	✓
	Wall Mounted A5VWM-SP		✓		✓		✓		✓		✓												

Note:

- The lineup is for indicative purposes, actual coupling will still depends on the outdoor unit. Please consult us should you need further assistance.
- Fresh air ducted blower only available for EcoPro series.

Outdoor Units

A5VRY A Alpha Series

Cooling Capacity (MBH)	Model	A5VRY080A	A5VRY100A	A5VRY120A
80	A5VRY080A	✓		
100	A5VRY100A		✓	
120	A5VRY120A			✓
140	A5VRY140A			
160	A5VRY160A			
180	A5VRY180A			
200	A5VRY200A			
220	A5VRY220A			
240	A5VRY240A		✓	
260	A5VRY260A		✓	
280	A5VRY280A		✓	
300	A5VRY300A			
320	A5VRY320A			
340	A5VRY340A			
360	A5VRY360A			
380	A5VRY380A			
400	A5VRY400A			
420	A5VRY420A			
440	A5VRY440A			
460	A5VRY460A			
480	A5VRY480A			
500	A5VRY500A			
520	A5VRY520A			
540	A5VRY540A			
560	A5VRY560A			
580	A5VRY580A			
600	A5VRY600A			
620	A5VRY620A			
640	A5VRY640A			
660	A5VRY660A			

A5VRY140A	A5VRY160A	A5VRY180A	A5VRY200A	A5VRY220A	Maximum Number of IDU
					16
					16
					16
✓					20
	✓				20
		✓			24
			✓		24
				✓	28
✓					28
	✓				32
		✓			32
✓	✓				36
✓		✓			36
	✓	✓			40
		✓✓			40
	✓			✓	44
		✓		✓	44
			✓	✓	48
				✓✓	48
✓✓		✓			52
✓	✓	✓			52
✓		✓✓			54
	✓	✓✓			54
		✓✓✓			56
	✓	✓		✓	56
		✓✓		✓	58
	✓			✓✓	58
		✓		✓✓	60
			✓	✓✓	60
				✓✓✓	64



ACSON
International
Air Conditioners

ACSON MALAYSIA SALES & SERVICE SDN. BHD.

a member of DAIKIN group

Business Registration NO.198401017130 (129688-D)

No. 7A, Jalan 13/4, Seksyen 13, 46200 Petaling Jaya,
Selangor Darul Ehsan, MALAYSIA.

Tel : +603 7964 8200 Sales Fax : +603 7956 9909

Service Fax : +603 7956 9907 Acson Careline : 1300 22 3344

Penang : +604-5377 176

Pahang : +609-5178 696

Perak : +605-3129 828

Kelantan : +609-7405 233

Melaka : +606-2926 196

Sarawak : +6082-344 128

Johor : +607-3551 599

Sabah : +6088-420 205

Authorized Dealer :



Products manufactured in an ISO certified facility.
This document contains the most current product information as of this printing.
For the most up-to-date product information, please logon to www.acson.com.my

CAT-A5VRY-2402

www.acson.com.my