

R32 LIGHT COMMERCIAL

Non-Inverter Split Type Air Conditioner



Product Lineup



Indoor Unit

Ceiling Cassette	 <p>A3CK15CF</p>	 <p>A3CK20FF</p>	 <p>A3CK25FF</p>	 <p>A3CK30FF</p>
Ceiling Concealed	 <p>A3CC15C</p>	 <p>A3CC20J</p>	 <p>A3CC25J</p>	 <p>A3CC30J</p>
Ceiling Mounted		 <p>A3CM20C</p>	 <p>A3CM25C</p>	 <p>A3CM30C</p>

Outdoor Unit

	 <p>A3LC15F3</p>	 <p>A3LC20F</p>	 <p>A3LC25F</p>	 <p>A3LC30F</p>
--	-----------------------------------------------------------------------------------------------------	----------------------------------------------------------------------------------------------------	-----------------------------------------------------------------------------------------------------	------------------------------------------------------------------------------------------------------



				Indoor Unit
 <p>A3CK35FF</p>	 <p>A3CK40FF</p>	 <p>A3CK50FF</p>		Ceiling Cassette
 <p>A3CC35J</p>	 <p>A3CC40J</p>	 <p>A3CC50J</p>	 <p>A3CC60J</p>	Ceiling Concealed
 <p>A3CM35C</p>	 <p>A3CM40C</p>	 <p>A3CM50C</p>	 <p>A3CM60C</p>	Ceiling Mounted
				Outdoor Unit
 <p>A3LC35D</p>	 <p>A3LC40D</p>	 <p>A3LC50D</p>	 <p>A3LC60D</p>	

MY Acson, MY Control

Built in Wi-Fi : R32 Ceiling Cassette , A3CK-CF & A3CK-FF SERIES

Optional Wi-Fi :R32 Ceiling Concealed A3CC-J, R32 Ceiling Mounted A3CM-C SERIES

Besides hassle-free from finding remote controller, all you need are MY Acson and your smartphone to improve your lifestyle, AC Usage, comfort and smart home experience.

Acson Wifi Adapter, AWM01A01

MY Acson App

Available Function

- Switch ON/OFF
- Operation Mode
- Fan Speed and Temperature Adjustment
- User sharing
- Zoning
- Error Code and History
- Weekly Timer
- Out of Home Control

MY Acson App

A single swipe on the phone application which designed with simple control user interface. MY Acson is currently available for Android, IOS and HarmonyOS systems.



MY Acson



MY Complete Control

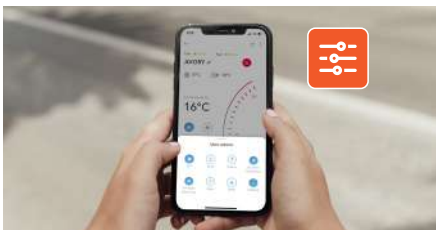

- Setting different modes to suit your needs and comfort.
- Controlling fan speed, air flow direction & temperature settings
- Controlling the Zoning System

MY Convenience



- Set 7-day schedules & timers that adjust AC according to your lifestyle
- Control every AC unit from your couch - no need to go racing room-to-room changing settings
- Guest sharing option - possible to be both hospitable and safe

MY Comfort



- Pre-cool your room whilst still in the workplace or office.
- Room is already pre-cooled according to your desired settings as you reach home.

Specification

Dimension	Height (mm)	32
	Width (mm)	50
	Depth (mm)	15
Wi-Fi Frequency	2.4GHz	
Network Configuration		
Out-of-home Control	Internet	
In-home Control	LAN, Bluetooth	
Electrical Specification		
Communication Protocol	NS	
Input Supply	Voltage	5V
	Current	150 mA
	Power Consumption	750 mW
Supported OS	Android 7 or later; IOS 9 or later	



Remarks:

1. For the full list compatible AC models, please refer to Acson Malaysia Smart Solution Website
2. The controllable function and feature may differ depending on the models.



Foresto Technology

Acson Foresto Technology brings you to the peace of the forest by combining powerful Plusma function, Filtronz+ and R32 greenery refrigerant. By supplying clean and fresh air, it helps to recharge your mind and soul, make resting more effective.



Indoor Air Quality

Acson R32 Ceiling Cassette comes with filter which incorporates Filtronz+ Anti Virus Technology as standard which effectively decompose virus and reduce bacteria & fungus on the filter surface.

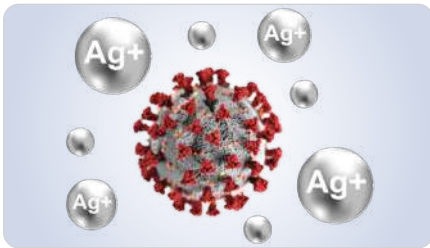

Step 1 Silver ions (Ag+) on the filter absorb virus to the filter surface

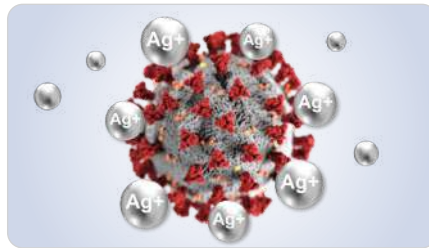

Step 2 Combination organic and inorganic components simultaneously react to the protein that exist on the virus surface.

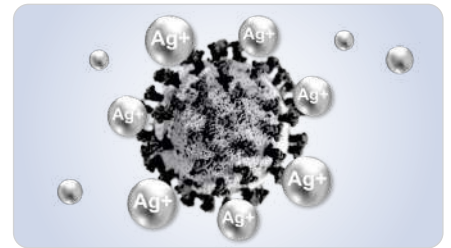

Step 3 Enzyme protein is inactivated, thus it leads the decomposition and avoid the spreading of the viruses.

Decomposition of Viruses

The effectiveness rate of virus decomposition is increased by 99% in 2 hours

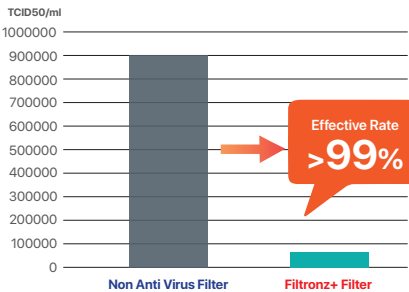

Reduction of Bacteria

The effectiveness rate of bacteria reduction is more than 99.99% in 24 hours

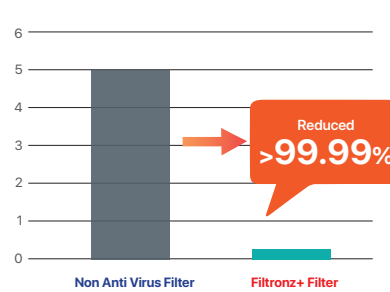

Reduction of Fungus

Generation of fungus achieved Grade 0 in 24 hours (No fungus visible under the microscope)

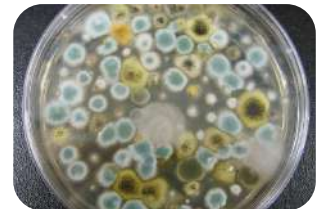

*Image is for illustration purposes

Test Measuring Method:

Textiles- Determination of antiviral activity of textile products (ISO 18184-2014)

Testing Organization: GuangDong Detection Center

Test Number: 2020FM24347R01, 2020FM2604R01

Test Measuring Method:

Test for antimicrobial activity of plastic (JIS Z 2801 : 2010)

Testing Organization: GuangDong Detection Center Of Microbiology

Test Number: 2021FM05003R01E

Tested Virus Specimen: Tested Virus Specimen: Influenza H1N1, Chicken Coronavirus Infectious Bronchitis Virus

Tested Bacteria Specimen: Escherichia Coli, Staphylococcus aureus

Tested Fungus: Aspergillus niger, Penicillium pinophilum, Trichoderma viride, Chaetomium globosum, Poecilomyces variotii

Plusma Technology



Unit comes with advance Plusma Technology which effectively deactivate bacteria by damaging those microbial DNA and their surface structures by this advanced Plusma Technology. It emits massive positive and negative ions, and sterilize surrounding air more effectively, providing fresh and clean environment to ensure optimal comfort of users.

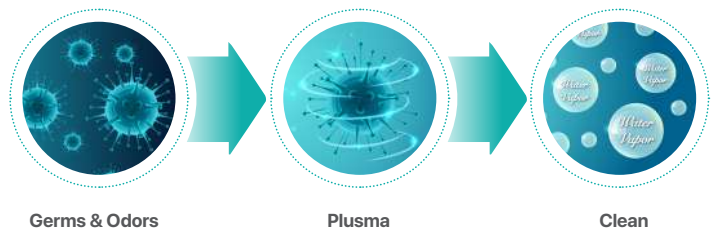



Model:
A3CK20/25/30/35/40/50FF

Nominal Cooling Capacity:
5.42kW ~ 14.07kW
18,500 BTU/h ~ 48,000 BTU/h



MY Acson



Acson R32 Ceiling Cassette FF Series is awarded by MyHIJAU Mark. MyHIJAU Mark is Malaysia's official green recognition scheme endorsed by the Government of Malaysia

*Applicable for model A3CK20/25/30/35/40/50FF

Built In Acson Network Adapter

Acson R32 Ceiling Cassette comes with built-in Acson network adapter and ready to be paired with MY Acson app, offering you the smart convenience to control and real time monitoring your air conditioners

Pairing Steps

1. Download MY Acson App



2. Please locate and scan the QR code sticker (besides MCMC label) on the warranty card or inside the wifi adaptor box to pair your AC with your smartphone.



3. Once pairing done, enjoy the smart control with MY Acson App.

Feature Ceiling Cassette

4 Dimensional Cooling Comfort

Four ways air discharge providing excellent cooled air distribution throughout the space. By taking every corner into consideration, it ensures optimal level of comfort. Air flow direction can be fixed at user's designated angle by the remote controller with Auto Mode.

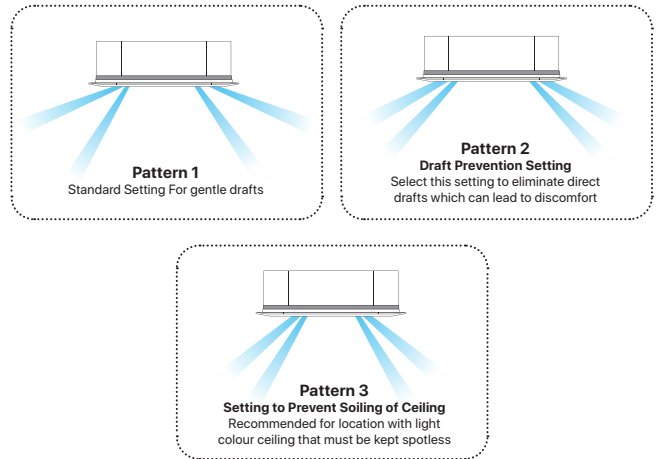

Slim and Stylish Design

Maintaining classy interior design in your home with slim and stylish panel design. The curvy edge and uniformity of panel size enabling it to blend in perfectly with any kind of space design.



Unit Dimension	Panel Dimension
840 x 840 mm	950 x 950 mm

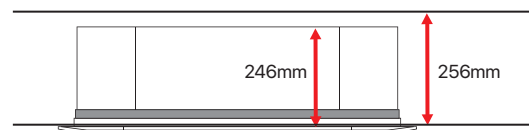

Model	Unit Height
A3CK20/25/30FF	246 mm
A3CK35/40/50FF	288 mm

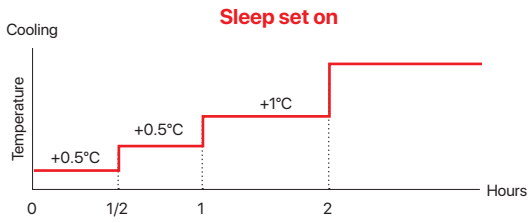

Comfortable Sleep Mode

Intelligent control system adjusts the temperature automatically according to surrounding environment. You can enjoy a good night's sleep by turning on Sleep Mode before you go to bed.

Built in Drainage System

The unit is equipped with highly efficient drain pump with 700 mm pressure head, providing smooth drainage of condensate water. A mechanism with safety water float is equipped to avoid overflow of water, giving users a worry-free experience.

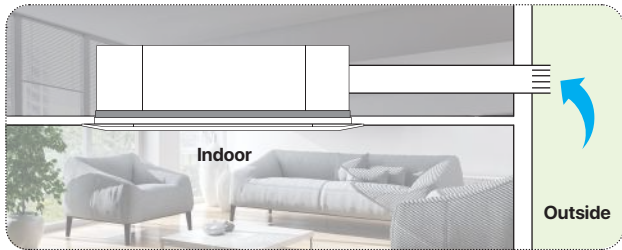
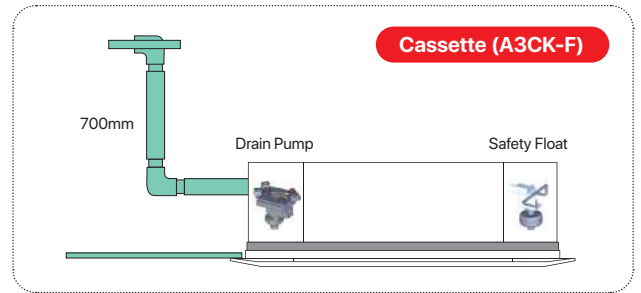

Fresh Air Intake

Optional fresh air intake mechanism according to user's preference. Knock-out hole is available on ceiling cassette indoor unit where a duct can be fitted to increase the intake of outdoor air. A fresher environment is made possible especially for places where ventilation fan is not installed.

Easy Height Adjustment

Each unit comes with adjustable cover pocket at four corners which are easy for adjusting the suspended height of unit. This in turns provide flexibility during installation where installer could adjust the hanging hook according to requirement. Technician could perform drainage leak check during servicing too.



Panel Hook Mechanism

Panel hook is utilized to support panel so that it could be hang on indoor unit, which provide a hassle-free installation experience by reducing manpower and accelerating the process.

Superior Performance

Upgraded Cooling Capacity

New R32 ceiling cassette is upgraded in terms of cooling capacity for certain models.*

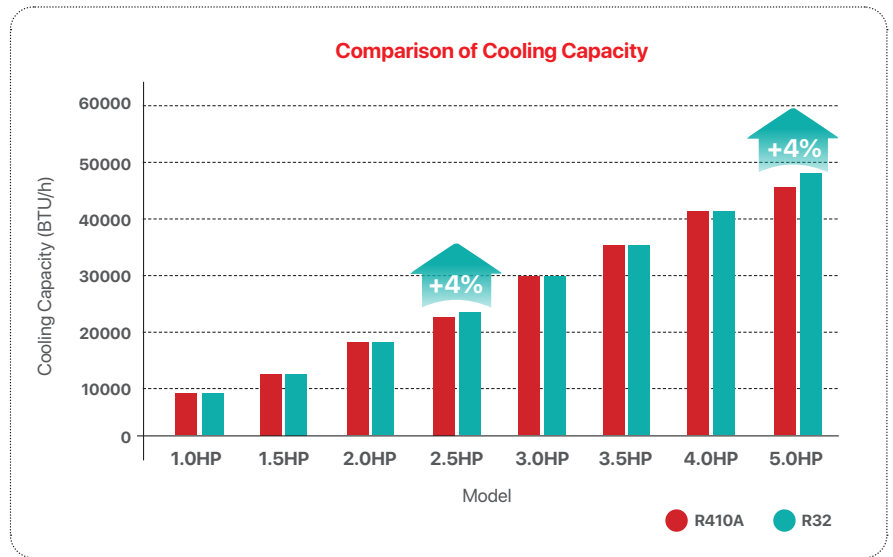

Improved Energy Efficiency

Acson R32 ceiling cassette has a remarkable performance by achieving higher energy efficiency standards than other similar models

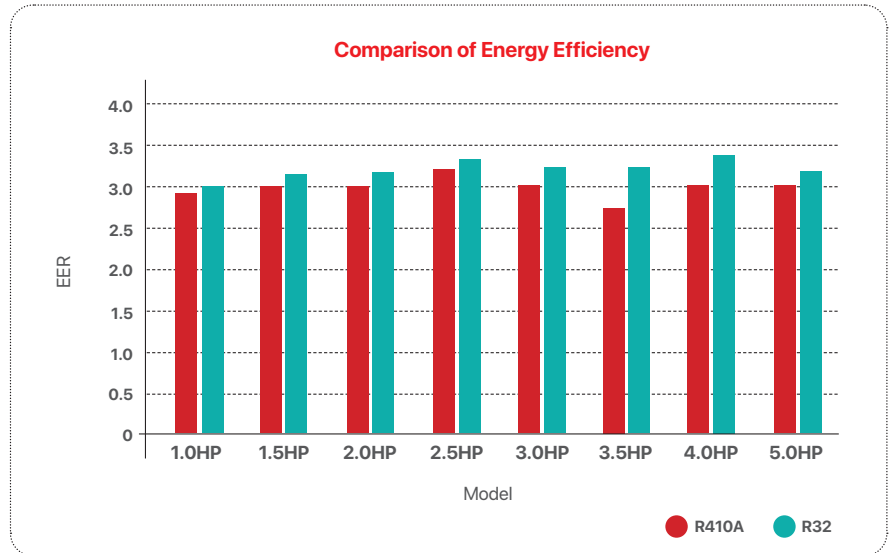

Higher Airflow

Airflow for 3.5HP R32 ceiling cassette is now upgraded to ensure higher airflow and users' comfort.**

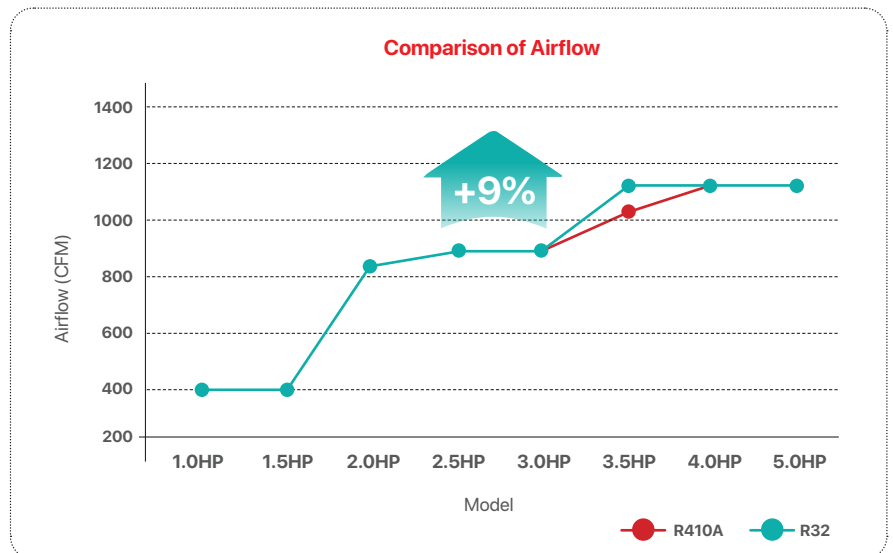

* Applicable for 2.5HP and 5.0HP models.

** Applicable for 3.5HP model.



Model:
A3CC20/25/30/35/40/50/60J

Nominal Cooling Capacity:
5.42kW ~ 16.12kW
18,500 BTU/h ~ 55,000 BTU/h

Feature Ceiling Concealed

Supreme Cooled Air Distribution

Cool air is effectively distributed throughout the whole room via ducting design. By taking every corner into consideration, it ensures optimal level of comfort. Multiple rooms can be cooled together with just a single unit.



Space Saving Design

Low Unit Height (For A3CC20-60J Series only)

The unit is sophisticatedly concealed inside the ceiling, thin unit design make it perfectly adequate to reserve the space for various interior design applications.

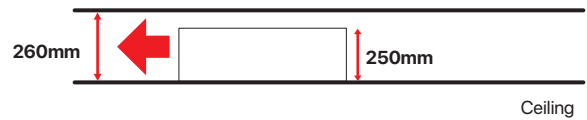

Model	Unit Height
A3CC20/25/30/35/40/50/60J	250 mm

Higher Flexibility (For A3CC20-60J Series only)

Easy conversion from rear return to bottom return is possible to be done on new R32 ceiling concealed to fit in according to building structures. Higher flexibility is available to cope with different customer requirements.

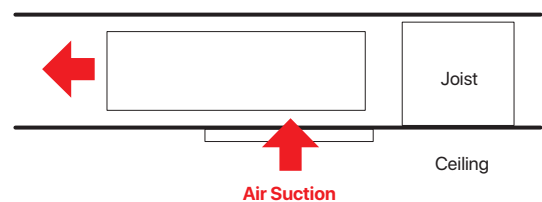

Flexible Installation

Selectable External Static Pressure (ESP) *(For A3CC20-60J Series only)*

Two different ESP can be easily selected by switching the connector inside the control box as shown below. According to duct design required for comfort, the adjustment can be done easily during installation at the control box.



ESP \ Model (HP)	A3CC20J	A3CC25J	A3CC30J	A3CC35J	A3CC40J	A3CC50J	A3CC60J
Factory Preset Value (Pa)	30	30	30	50	50	50	50
Optional (Switchable) Value (Pa)	50	50	50	80	80	80	60

Lightweight Drain Pan *(For A3CC20-60J Series only)*

New ceiling concealed comes with lightweight drain pan that will not get rust easily and ease the installation works. A slope is created on drain pan to drain water efficiently.

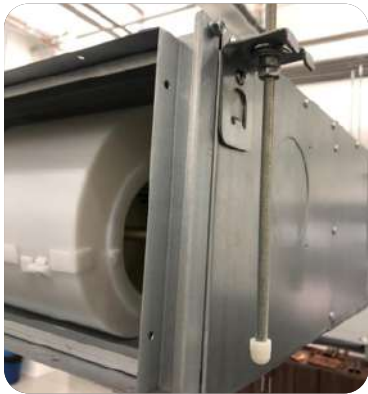
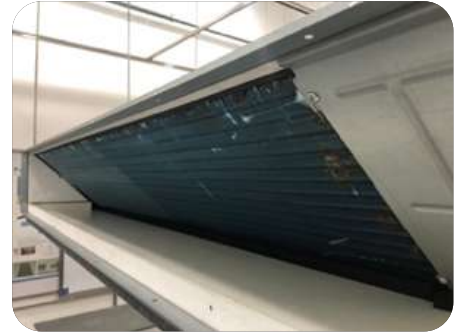

Pre-Installed Filter Rail

Pre-installed filter rail provides flexibility during installation. With the application of air filter, user can now enjoy better indoor air quality according to requirements. Filters could be purchased as optional accessories.

More Drainage Option

Drainage pump helps to channel the condensate water more effectively. Optional drainage pump could be purchased as accessory and installed at the designated location of the ceiling concealed unit.

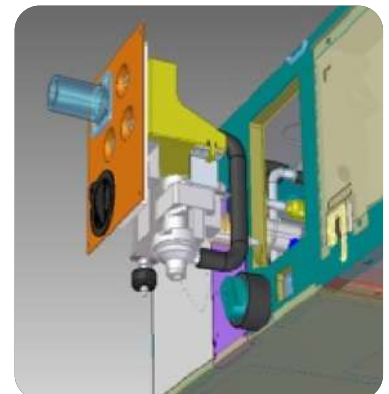

Better Serviceability *(For A3CC20-60J Series only)*

Drain Pan Maintenance Check Window

New drain pan maintenance check window located at side of the ceiling concealed, allowing technician to check the condition of drainage or dirt in the drain pan without using any additional tools.

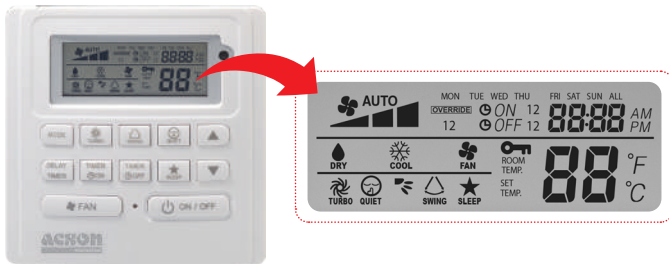
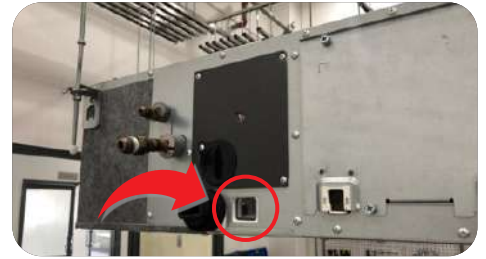

Weekly Schedule Timer

Available in Timer 1 & Timer 2 with operation of ON/OFF settings programmed for each day of the week. Schedule timer can be set either from Monday to Sunday or all (timer activate for 7days). Setting on ON/OFF operations only.

Easy Accessible to Components *(For A3CC20-60J Series only)*

Blower & Motor

Components such as blowers and motors could be easily accessible by removing the rear bottom panel and mid flange (as shown in the diagram). Blowers could be removed from the housing easily by opening the housing case, enabling better serviceability.

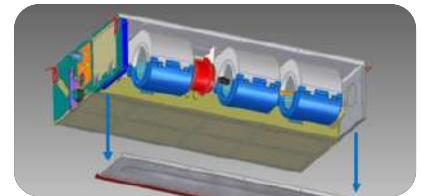

Drain Pan & Coil

Drain pan and coil can be easily accessible by removing front bottom panel and mid flange. The coil can be accessed once technician removed the drain pan.

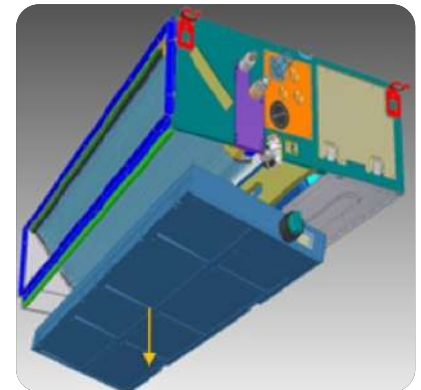

Optional NS Splitter with Network Adaptor



Acson NS Splitter



With optional Acson NS Splitter which comes together with network adaptor offering you the smart convenience to control and real time monitoring your air conditioners at your fingertips. With intelligent weekly timer, you can set your air conditioner units to accommodate your daily routine.

On an exceptionally hot day, you can switch on the air conditioner first and enjoy the cooling breeze once you reach home without the hassle of finding the remote controller.

Superior Performance

Extraordinary Cooling Performance

Users can now enjoy an extraordinary cooling experience with our new R32 ceiling concealed lineup. *

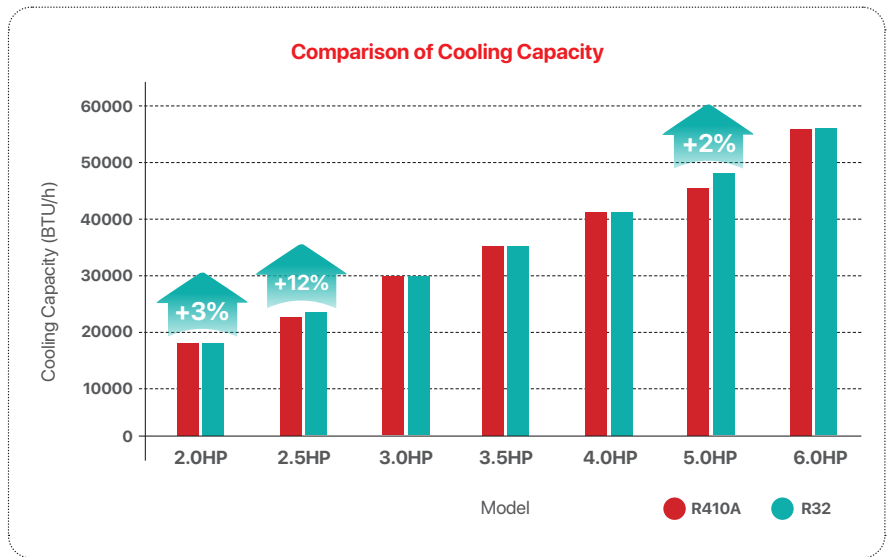
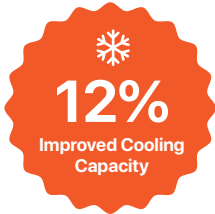

Energy Saving to the Next Level

Whole Acson R32 ceiling concealed lineup achieved a remarkable performance by improving energy efficiency compared to R410A models.

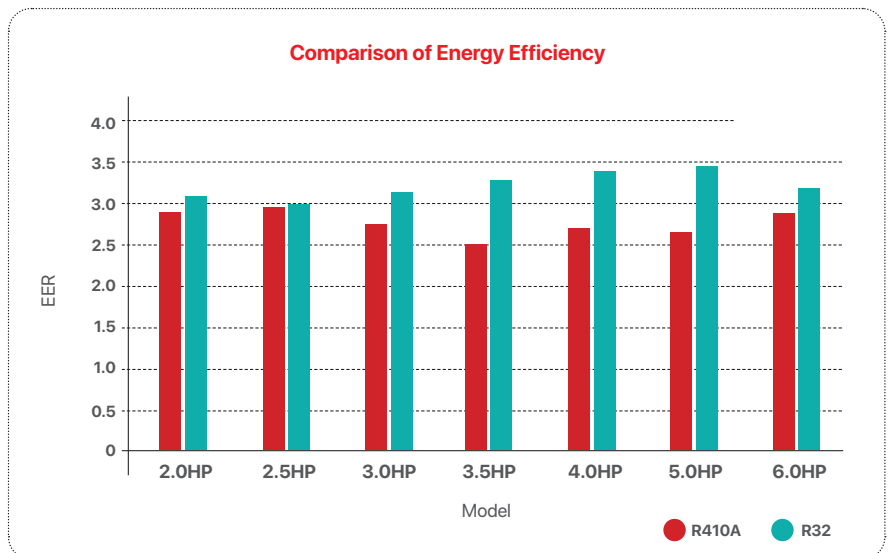

More Silent, More Powerful

New R32 ceiling concealed units are improved in terms of noise level. It is perfect to be installed in an environment where lower noise level is required to ensure users' comfort.**

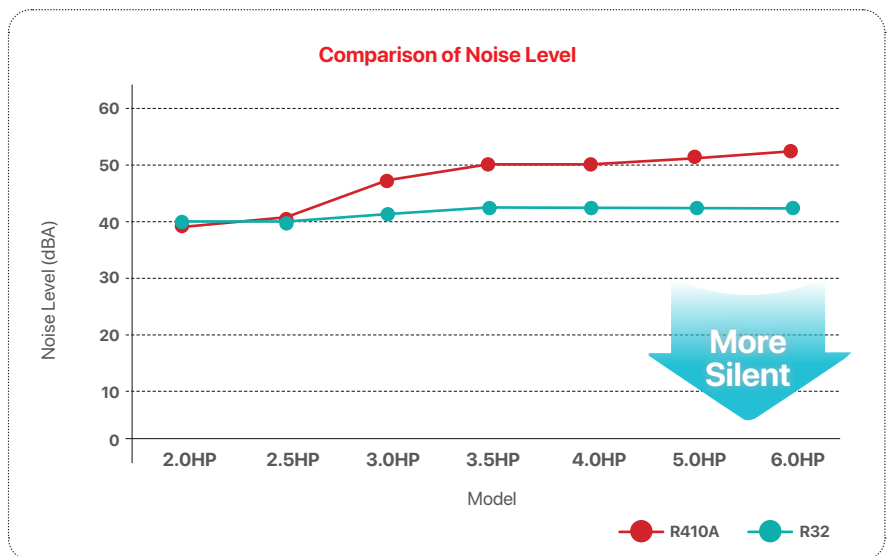

* Applicable for 2.0HP, 2.5HP and 5.0HP models.

** Applicable for all models except 2.0HP.



Model:
A3CM20/25/30/35/40/50/60C

Nominal Cooling Capacity:
5.4kW ~ 16.1kW
18,500 BTU/h ~ 55,000 BTU/h

Feature Ceiling Mounted

Aesthetically Compact Design

Slim and compact design easy for installation especially at corner which has narrow space. White stylish design easily blended with interior design.

Fast Cooling Comfort

Desired cooling comfort room is achieved rapidly through wide air throw range and consistent optimum air distribution by the motorized louver. Maximum air throw can reach up to 16.5m.

Service and Maintenance at Ease

The new design of intake grille makes it easier to lock and unlock. Easy access of filter cleaning can be done by just pulling down the intake grille. During servicing or repairing, only the bottom panel is needed to be removed in order to access to fan motor, control box and piping.

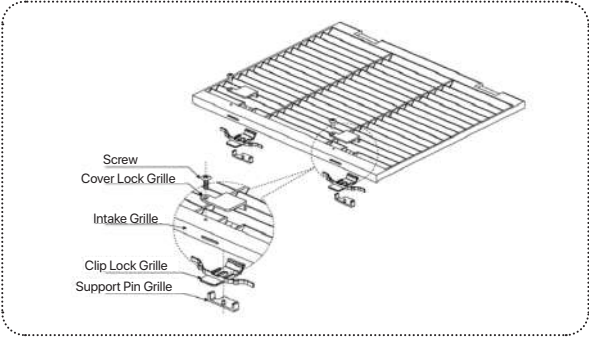

Improved Quality Satisfaction

Extra Insulation has been added on the air discharge and overall unit to countermeasure unit against sweat. It takes reliable cooling performance to another step forward.



Flexible Installation

Compact design for smaller capacity models to meet tighter dimensional constraints. The new technology makes it possible for piping elevation to go up to 30m and the piping length can be extended up to 50m. More flexibility and versatility to position your outdoor units with longer piping length and elevation.

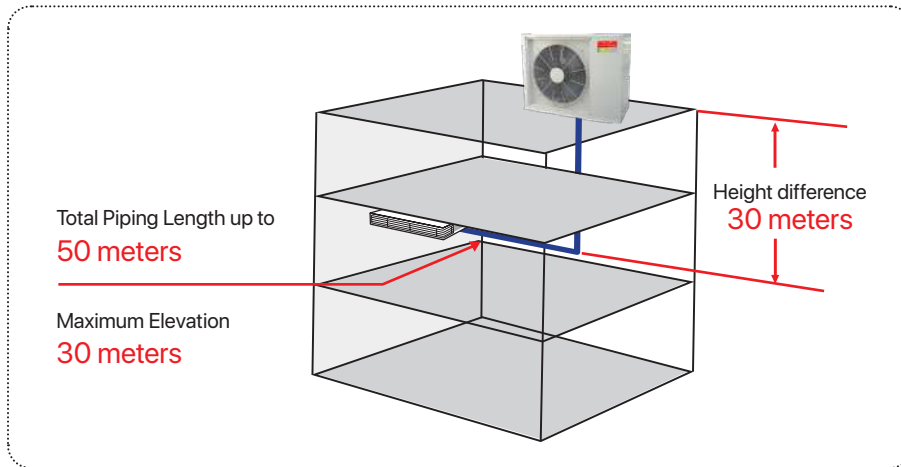

*Applicable for A3CM30C, A3CM35C, A3CM40C, A3CM50C and A3CM60C only.

More Drainage Option

The unit is designed to work with optional high pressure head drain pump, which offers ideal solution for installation on condensate drain pipe. A peace of mind for the consumer as a safety float is incorporated in the drain pump as safety protection.

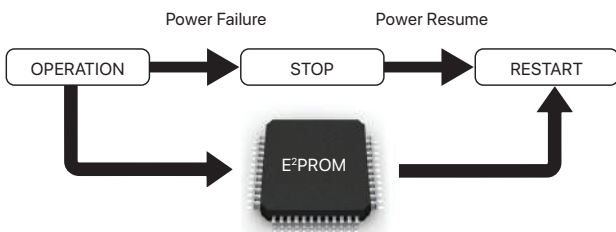

Auto Random Restart with Last-State-Memory

If there is any sudden power failure during operation, unit will restarts automatically in 64 different recovery timing patterns and the unit will operate based on the previous setting (operating mode, temperature setting and fan speed). This is to ensure that air conditioners in the same building resume randomly instead of all units resuming at the same time to prevent power surge after a blackout

With optional Acson Wi-Fi Adapter together with MY Acson app offering you the smart convenience to control and real time monitoring your air conditioners at your fingertips. With intelligent weekly timer, you can set your air conditioner units to accommodate your daily routine. On an exceptionally hot day, you can switch on the air conditioner first and enjoy the cooling breeze once you reach home without the hassle of finding the remote controller.

Superior Performance

Higher Cooling Performance

Cooling Capacity of R32 Ceiling Mounted for 2.0HP and up to 5.0HP are increased to make sure the user to stay relax and cool all day long.

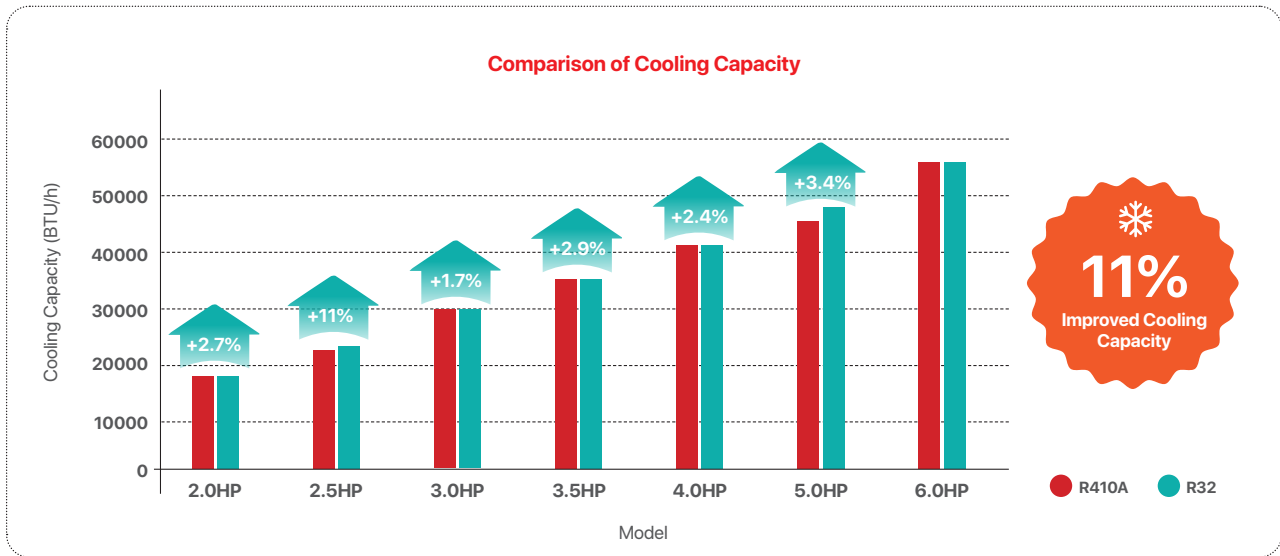

Greener Choices for Improved Energy Saving

Due to energy saving is one of the user's main concern, we improved the whole line up of R32 ceiling mounted energy efficiency to offer peace of mind.

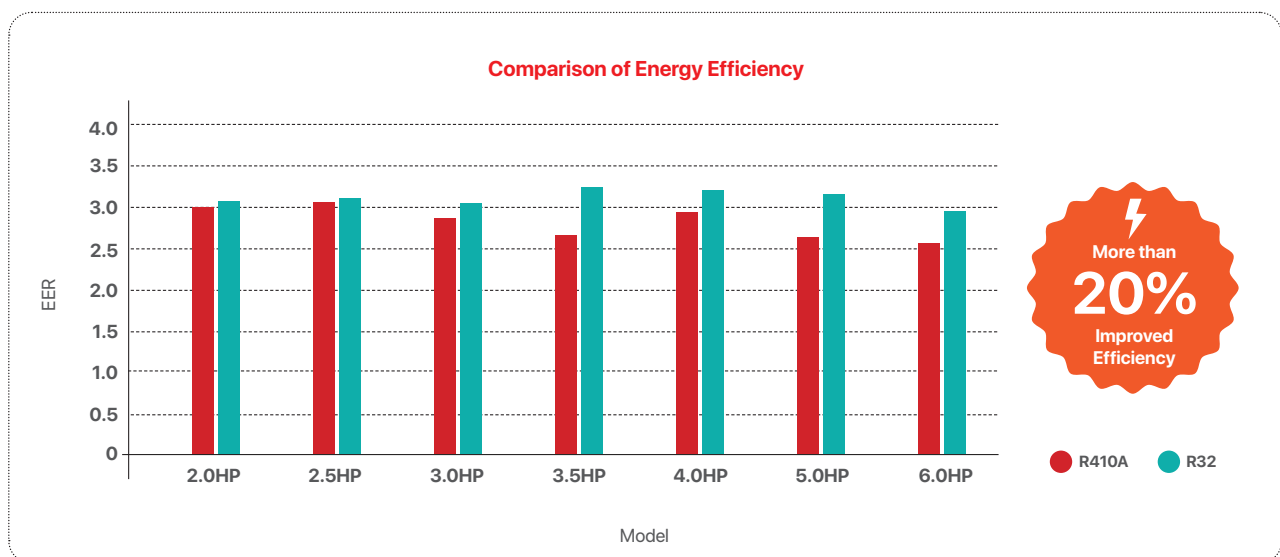

Functionality



✔ Standard ✔ Optional

Category	Functions	Ceiling Cassette	Ceiling Concealed	Ceiling Mounted
Operation	Auto Mode	✔	✔	✔
	Cool Mode	✔	✔	✔
	Dry Mode	✔	✔	✔
	Fan Mode	✔	✔	✔
	Sleep Mode	✔	✔	✔
Comfort	4-Ways Airflow	✔		
Convenience	Auto Fan Speed	✔	✔	✔
	Indoor unit On/Off Button	✔	✔	✔
	Signal Receiving Sign	✔	✔	✔
	Temperature Display	✔	✔	✔
	Weekly Timer	✔	✔	✔
	24-Hour On/Off Timer	✔	✔	✔
Feature	Auto Swing	✔	✔	
	Swing Pattern Selection	✔	✔	✔
	Switchable Fan Speed	✔	✔	✔
	Anti-Corrosion Outdoor Gold Fin	✔	✔	✔
Health	Saranet Filter		✔	✔
	Filtronz+ Filter	✔		
	Plusma Technology	✔		
	Washable Grille	✔		✔
Durability	Power Failure Memory System	✔	✔	✔
	Self-Diagnosis	✔	✔	✔
	Wiring Error Check Function	✔	✔	✔
Accessory	Wireless Remote Controller	✔	✔	✔
	Wired Remote Controller	✔	✔	✔
	External Static Pressure Selection		✔	
	Drain Pump	✔	✔	
	Fresh Air Intake	✔		
	Switchable Temperature Display (°C/°F)	✔	✔	✔

Remarks

1. Installation and maintenance should be performed by qualified persons who are familiar with local code and regulation, and experienced with this type of appliance.
2. All field wiring must be installed in accordance with the national wiring regulation.
3. When the pipe length becomes too long, both the capacity and reliability drop.
4. As the number of bends increase, resistance to flow of refrigerant system increases, thus lowering cooling capacity and as a result the compressor may become defective.
5. Always choose the shortest path and follow the recommendation of authorised personnels.

Technical Specification

Ceiling Cassette



A3CK15CF



A3CK20/25/30/35/40/50FF

Model		Indoor Unit	A3CK15CF	A3CK20FF	A3CK25FF	A3CK30FF	A3CK35FF	A3CK40FF	A3CK50FF	
		Outdoor Unit	A3LC15F3	A3LC20F	A3LC25F	A3LC30F	A3LC35D	A3LC40D	A3LC50D	
Nominal Cooling Capacity		BTU/h	12500	18500	24000	30000	36000	42000	48000	
		kW	3.66	5.42	7.03	8.79	10.55	12.31	14.07	
Nominal Total Input Power		W	1115	1680	2130	2710	3150	3620	4100	
Nominal Running Current		A	4.94	7.46	9.45	12.10	14.30	6.78	7.59	
CSPF		W/W	3.49	3.43	3.50	3.44	3.56	3.61	3.64	
Power Source		V/Ph/Hz						380-415/3/50		
Indoor Unit	Air Flow	CFM	410/360/330	840/700/560/440	890/760/620/490		1120/1030/890/760			
	Sound Pressure Level (H/M/L)	dBA	41/38/35	42/39/37/35	44/40/37/35		48/46/43/40			
	Unit Dimension (H x W x D)	mm (in)	250 x 570 x 570 (9.84 x 22.44 x 22.44)	246 x 840 x 840 (9.69 x 33.07 x 33.07)		288 x 840 x 840 (11.34 x 33.07 x 33.07)				
	Unit Dimension With Panel (H x W x D)	mm (in)	295 x 640 x 640 (11.61 x 25.20 x 25.20)	301 x 950 x 950 (11.85 x 37.40 x 37.40)		343 x 950 x 950 (13.50 x 37.40 x 37.40)				
	Unit Weight	kg	15.5	22		25				
	Unit Weight With Panel	kg	17.5	27		30				
	Condensate Drain Size	mm								
Outdoor Unit	Sound Pressure Level	dBA	48	52		54	56	58	60	
	Unit Dimension (H x W x D)	mm (in)	550 x 658 x 273 (21.65 x 25.91 x 10.75)	615 x 845 x 300 (24.21 x 33.27 x 11.81)		695 x 930 x 350 (27.36 x 36.61 x 13.78)	852 x 1030 x 400 (33.54 x 40.55 x 15.75)			
	Unit Weight	kg	28	40	46	53	62	79	84	
	Pipe Connection	Liquid	mm (in)	6.35 (1/4)			9.53 (3/8)			
		Gas	mm (in)	9.52 (3/8)	12.70 (1/2)		15.88 (5/8)			
	Maximum Piping Length	m (ft)	25 (82.02)	35 (114.83)		50 (164.04)				
	Maximum Piping Elevation	m (ft)	15 (49.21)	20 (65.62)		30 (98.43)				
Refrigerant										

- All specifications are subjected to change by the manufacturer without prior notice
- Nominal Cooling Capacity is based on the conditions : Cooling 27°C DB/ 19°C WB indoor and 35°C DB outdoor



GS02 (Default)



SLM9 (Optional)



A3LC15F3



A3LC20/25/30F



A3LC35/40/50D

Technical Specification

Ceiling Concealed



A3CC15C



A3CC20/25/30/35/40/50/60J

Model		Indoor Unit	A3CC15C	A3CC20J	A3CC25J	A3CC30J	A3CC35J	A3CC40J	A3CC50J	A3CC60J	
		Outdoor Unit	A3LF15F3	A3LC20F	A3LC25F	A3LC30F	A3LC35D	A3LC40D	A3LC50D	A3LC60D	
Nominal Cooling Capacity	BTU/h		12000	18500	23500	30000	36000	42000	48000	55000	
	kW		3.52	5.42	6.89	8.79	10.55	12.31	14.07	16.12	
Nominal Total Input Power	W		1143	1750	2290	2770	3200	3660	4100	4950	
Nominal Running Current	A		5.05	7.74	10.3	12.4	14.8	6.85	7.51	8.73	
CSPF	W/W		3.27	3.29	3.20	3.37	3.50	3.57	3.64	3.46	
Power Source	V/Ph/Hz		220-240/1/50					380-415/3/50			
Indoor Unit	Air Flow	CFM	510/460/350	590/525/430		950/810/700		1260/1095/920		1400/1280/1120	
	External Static Pressure (H/M/L) / (Std/H)	Pa	10/08/05	30/50			50/80			50/60	
	Sound Pressure Level (H/M/L)	dBA	36/33/29	40/37/34		41/38/35		42/39/36		43/42/39	
	Unit Dimension (H x W x D)	mm (in)	261 x 905 x 411 (10.28 x 35.63 x 26.18)	250 x 700 x 700 (9.84 x 27.56 x 27.56)		250 x 1000 x 700 (9.84 x 39.37 x 27.56)		250 x 1400 x 700 (9.84 x 55.12 x 27.56)			
	Unit Weight	kg	22	24		31		40		42	44
	Condensate Drain Size	mm	ø19	32.00							
Outdoor Unit	Sound Pressure Level	dBA	48	52		54	56	58	60	62	
	Unit Dimension (H x W x D)	mm (in)	550 x 658 x 273 (21.65 x 25.91 x 10.75)	615 x 845 x 300 (24.21 x 33.27 x 11.81)		695 x 930 x 350 (25.94 x 36.61 x 13.78)		852 x 1030 x 400 (33.54 x 40.55 x 15.75)			
	Unit Weight	kg	28	40	46	53	62	79	84	94	
	Pipe Connection	Liquid	mm (in)	6.35 (1/4)		9.53 (3/8)					
		Gas	mm (in)	9.52 (3/8)		12.70 (1/2)		15.88 (5/8)		19.15 (3/4)	
	Maximum Piping Length	m (ft)	25 (82.02)		35 (114.83)		50 (164.04)				
	Maximum Piping Elevation	m (ft)	15 (49.21)		20 (65.62)		30 (98.43)				
	Refrigerant		R32								

1. All specifications are subjected to change by the manufacturer without prior notice
2. Nominal Cooling Capacity is based on the conditions : Cooling 27°C DB/ 19°C WB indoor and 35°C DB outdoor



GS02 (Optional)



SLM9 (Default)



A3LC15F3



A3LC20/25/30F



A3LC35/40/50/60D

Technical Specification

Ceiling Mounted



A3CM20/25/30/35/40/50/60C

Model		Indoor Unit	A3CM20C	A3CM25C	A3CM30C	A3CM35C	A3CM40C	A3CM50C	A3CM60C
		Outdoor Unit	A3LC20F	A3LC25F	A3LC30F	A3LC35D	A3LC40D	A3LC50D	A3LC60D
Nominal Cooling Capacity		BTU/h	18,500	23,500	29,500	36,000	42,000	46,000	55,000
		kW	5.42	6.89	8.65	10.55	12.31	13.50	16.12
Nominal Total Input Power		W	1785	2220	2860	3250	3860	4300	5500
Nominal Running Current		A	8.05	9.88	12.80	14.70	7.14	7.93	9.62
CSPF		W/W	3.23	3.29	3.21	3.45	3.39	3.33	3.11
Power Source		V/Ph/Hz	220-240/1/50				380-415/3/50		
Indoor Unit	Air Flow	CFM	620/600/490		830/730/625	1125/1030/960			1460/1390/1150
	Sound Pressure Level (H/M/L)	dBA	47/46/43		48/45/42	52/50/48			55/53/50
	Unit Dimension (H x W x D)	mm (in)	235 x 1,175 x 669 (9.25 x 46.26 x 26.34)		235 x 1,525 x 669 (9.25 x 60.04 x 26.34)	235 x 1,875 x 669 (9.25 x 73.82 x 26.34)			
	Unit Weight	kg	33		41	50			60
	Condensate Drain Size	mm	19.00						
Outdoor Unit	Sound Pressure Level	dBA	52		54	56	58	60	62
	Unit Dimension (H x W x D)	mm (in)	615 x 845 x 300 (24.21 x 33.27 x 11.81)		695 x 930 x 350 (27.36 x 36.61 x 13.78)	852 x 1030 x 400 (33.54 x 40.55 x 15.75)			
	Unit Weight	kg	40	46	53	62	79	84	94
	Pipe Connection	Liquid	mm (in)	6.4 (1/4)		9.5 (3/8)			
		Gas	mm (in)	12.7 (1/2)		15.9 (5/8)			19.1 (3/4)
	Maximum Piping Length	m (ft)	35 (114.83)		50 (164.04)				
	Maximum Piping Elevation	m (ft)	20 (65.62)		30 (98.43)				
Refrigerant		R32							

- All specifications are subjected to change by the manufacturer without prior notice
- Nominal Cooling Capacity is based on the conditions : Cooling 27°C DB/ 19°C WB indoor and 35°C DB outdoor



GS02 (Default)



SLM9 (Optional)



A3LC20/25/30F



A3LC35/40/50D



ACSON MALAYSIA SALES & SERVICE SDN. BHD.
a member of DAIKIN group

Business Registration NO.198401017130 (129688-D)

No. 7A, Jalan 13/4, Seksyen 13, 46200 Petaling Jaya,
Selangor Darul Ehsan, MALAYSIA

Tel : +603 7964 8200 Sales Fax : +603 7956 9909

Service Fax : +603 7956 9907 Acson Careline : 1300 22 3344

Penang	: +604-5377 176	Pahang	: +609-5178 696
Perak	: +605-3129 828	Kelantan	: +609-7405 233
Melaka	: +606-2926 196	Sarawak	: +6082-344 128
Johor	: +607-3551 599	Sabah	: +6088-420 205

www.acson.com.my

Authorized Dealer :

Products manufactured in an ISO certified facility.
This document contains the most current product information as of this printing.
For the most up-to-date product information, please logon to www.acson.com.my

CAT-A3CK,A3CC,A3CM-2404